

ELECRAFT® K3

HIGH-PERFORMANCE 160 – 6 METER TRANSCEIVER

K3 KIT ASSEMBLY MANUAL

PRELIMINARY

September 10, 2007

Copyright © 2007, Elecraft, Inc.

All Rights Reserved

Contents

Introduction.....	1
Customer Service and Support.....	1
Technical Assistance.....	1
Preventing Electrostatic Discharge Damage.....	3
How ESD Damage Occurs.....	3
Preventing ESD Damage.....	3
Preparing for Assembly.....	4
Overview of the Kit.....	4
Tools and Test Equipment Required.....	6
Unpacking and Inventory.....	7
Screws.....	7
Standoffs.....	8
Lock Washers.....	8
Assembly.....	9
RF Board and Chassis.....	9
Circuit Description.....	9
RF Board and Chassis Assembly Procedure.....	11
KANT3 or KAT3 and Rear Panel.....	19
Circuit Description.....	19
KANT3 or KAT3 and Rear Panel Installation Procedure.....	19
KIO3 Interface.....	22
KIO3 Circuit Description.....	22
KIO3 Interface Installation Procedure.....	23
Front Panel and DSP.....	25
Circuit Description.....	25
Front Panel Assembly Procedure.....	26
Resistance Checks.....	34
Initial Power On Check.....	35
KREF3.....	36
Circuit Description.....	36
KREF3 Installation Procedure.....	36
KSYN3.....	37
Circuit Description.....	37
KSYN3 Installation Procedure.....	38
KPA3 Installation.....	39
Bottom Cover.....	39
Bottom Cover Installation.....	40
Battery BT1.....	41
Battery BT1 Function.....	41
Battery BT1 Installation Procedure.....	42
Top Cover and Speaker.....	42
Test and Calibration.....	44
Initial Power Checks.....	44
Synthesizer Calibration.....	45
Filter Setup.....	45
Option Modules.....	45
Transmitter Test.....	45
Wattmeter Calibration (Optional).....	45
Reference Oscillator Frequency (Optional).....	45
KPA3 100-Watt Module Installation.....	46

Appendix A, Illustrated Parts List	A1
Appendix B, K3 Functional Block Diagram.....	B1

List of Figures

Figure 1. Assembled Basic K3/10 (Less Top Cover).....	5
Figure 2. Screw Sizes Used in Assembly.....	7
Figure 3. Typical Standoff.	8
Figure 4. Lock Washers.	8
Figure 5. 2D Fastener Location on RF Board.	11
Figure 6. Installing 2D Fasteners on RF Board.....	12
Figure 7. Noise Blanker Standoff Location.	12
Figure 8. KNB3 Noise Blanker and KR MXR Mixer Standoff Hardware Installation.	12
Figure 9. KR MXR Mixer Standoff Location.	12
Figure 10. Installing Q3 Hardware on RF Board.	13
Figure 11. Installing Crystal I.F. Filters on RF Board.	13
Figure 12. RF Board Partially Assembled.	14
Figure 13. Installing the Low Power Amplifier (LPA).	15
Figure 14. Installing Front Panel Shield.....	16
Figure 15. Installing KR MXR Mixer and KNB3 Noise Blanker Boards.....	16
Figure 16. Installing Side Panel Feet.	17
Figure 17. Installing Side Handle Mounting Hardware.	17
Figure 18. Mounting Left Side Panel.	18
Figure 19. Installing Left Side Panel 2D Fastener.	18
Figure 20. Attaching U12 and U13 to the Right Side Panel.	19
Figure 21. Mounting the ANT1 Connector.....	19
Figure 22. Mounting 2D fastener for KANT3 Standoff.....	20
Figure 23. KANT3 Mounting Standoff.....	20
Figure 24. Installing the KANT3 or KAT3 Board.....	20
Figure 25. Installing the Rear Panel.....	21
Figure 26. ANT Connections to KANT3 or KAT3 Boards.....	21
Figure 27. Installing Rear Panel Hole Plugs.....	22
Figure 28. Attaching Serial Number.....	22
Figure 29. Installing Rear Panel Ground Screw.....	22
Figure 30. Preparing Rear Panel for KIO3 Installation.....	23
Figure 31. Preparing the KIO3 Board for Installation.....	24
Figure 32. Installing KIO3 Main Board.....	24
Figure 33. Installing the KIO3 Digital I/O Board.....	25
Figure 34. Mounting KIO3 Connector Panel.....	25
Figure 35. Preparing the Front Panel Board for Mounting, Part 1.....	27
Figure 36. Preparing the Front Panel Board for Mounting, Part 2.....	27
Figure 37. Mounting the Front Panel on the Front Panel Board.....	28
Figure 38. Preparing VFO Encoders for Mounting.....	28
Figure 39. Mounting VFO Encoders.....	29
Figure 40. Mounting VFO A Trim Panel.....	29
Figure 41. Installing LCD Cover.....	30
Figure 42. Mounting Concentric Knobs.....	30
Figure 43. Mounting Friction Knobs.....	31
Figure 44. Mounting the VFO A Tuning Knob.....	31
Figure 45. Mounting the VFO B Knob.....	32

Figure 46. Mounting the DSP Board.....	33
Figure 47. Mounting the Front Panel Assembly on the Chassis.	34
Figure 48. R36 Test Point.	35
Figure 49. U12 and U13 Test Points.	35
Figure 50. Installing KREF3 Board.	36
Figure 51. Installing KREF3 Oscillator Module.	37
Figure 52. Installing the KSYN3 Board.....	38
Figure 53. TMP Cable Connectors.....	38
Figure 54. Installing KREF3 TMP Cables.	39
Figure 55. Installing Standoffs on RF Board.	40
Figure 56. Installing Rear Feet.....	40
Figure 57. Installing Tilt Stand.	41
Figure 58. Installing BT1.	42
Figure 59. Attaching Chassis Stiffener to Top Cover.	42
Figure 60. Mounting Loudspeaker.	43
Figure 61. Installing Speaker Magnet Shield.	43
Figure 62. Connecting Speaker to KIO3 Board.	44

PRELIMINARY

Introduction

This is the assembly manual for the Elecraft K3 High Performance 160 – 6 meter transceiver modular kit.

Full details of the Elecraft K3 and its options, including specifications, installation, operation, troubleshooting and maintenance instructions are included in the Owner's Manual which accompanies this kit.

Even though the K3 is an advanced, multimode transceiver, you'll be surprised at how easy this no-solder, modular kit is to assemble. Only a few basic hand tools are needed (see page 6). Only a few pre-fabricated cables are used in the K3. Nearly all interconnections are made through connectors mounted on the circuit boards themselves.

Customer Service and Support

Technical Assistance

You can send e-mail to support@elecraft.com and we will respond quickly - typically the same day Monday through Friday. Telephone assistance is available from 9 A.M. to 5 P.M. Pacific time (weekdays only) at 831-662-8345. Please use e-mail rather than calling when possible since this gives us a written record of the details of your problem and allows us to handle a larger number of requests each day.

Repair / Alignment Service (We want to make sure everyone succeeds!)

If necessary, you may return your Elecraft product to us for repair or alignment. (Note: We offer unlimited email and phone support to get your kit running, so please try that route first as we can usually help you find the problem quickly.)

IMPORTANT: You must contact Elecraft before mailing your product to obtain authorization for the return, what address to ship it to and current information on repair fees and turn around times. (Frequently we can determine the cause of your problem and save you the trouble of shipping it back to us.) Our repair location is different from our factory location in Aptos. We will give you the address to ship your kit to at the time of repair authorization. *Packages shipped to Aptos without authorization will incur an additional shipping charge for reshipment from Aptos to our repair depot.*

Elecraft 1-Year Limited Warranty

This warranty is effective as of the date of first consumer purchase. It covers both our kits and fully assembled products. For kits, before requesting warranty service, you should fully complete the assembly, carefully following all instructions in the manual.

What is covered: During the first year after date of purchase (or if shipped from factory, date product is shipped to customer), Elecraft will replace defective or missing parts free of charge (post-paid). We will also correct any malfunction to kits or assembled units caused by defective parts and materials. Purchaser pays inbound shipping to us for warranty repair, we pay shipping to return the repaired equipment to you by UPS ground service or equivalent to the continental USA and Canada. Alaska, Hawaii and outside U.S. and Canada actual return shipping cost paid by owner.

What is not covered: This warranty does not cover correction of kit assembly errors. It also does not cover misalignment; repair of damage caused by misuse, negligence, or builder modifications; or any performance malfunctions involving non-Elecraft accessory equipment. The use of acid-core solder, water-soluble flux solder, or any corrosive or conductive flux or solvent will void this warranty in its entirety. Also not covered is reimbursement for loss of use, inconvenience, customer assembly or alignment time, or cost of unauthorized service.

Limitation of incidental or consequential damages: This warranty does not extend to non-Elecraft equipment or components used in conjunction with our products. *Any such repair or replacement is the responsibility of the customer. Elecraft will not be liable for any special, indirect, incidental or consequential damages, including but not limited to any loss of business or profits.*

PRELIMINARY

Preventing Electrostatic Discharge Damage

There is no climate or work location where the components of your K3 are safe from Electrostatic Discharge (ESD) unless you take specific steps to prevent such damage. Many of the components in your K3 can be damaged by static discharges of only a few volts: far too little for you to notice. It is those low-voltage but destructive discharges that easily happen anywhere and under virtually any environmental conditions.

ESD damage may not be apparent at first. The damaged components may not fail completely. Instead, the damage may result in below-normal performance for an extended period of time before you experience a total failure.

How ESD Damage Occurs

Whenever an object containing a static charge touches a circuit in your K3, current will rush into the circuit until the components reach the same voltage as the source of the static charge. If the voltage or current that passes through a component in your K3 during that brief period exceeds its normal operating specifications, it may be damaged or destroyed.

Preventing ESD Damage

ESD damage cannot occur if there is no voltage difference between the components in your K3 and any object that touches them. That is how anti-static packaging works. Anti-static bags allow the static charge to flow over their surface, so that any part of the bag that touches the components inside are all at the same potential at all times. Anti-static foam keeps the leads of sensitive components at the same potential.

At your work bench, avoiding a dangerous voltage is achieved most easily by tying everything together and connecting them to a common mains safety ground. This includes your K3, individual boards or other sensitive components as well as everything they may touch at the work table.

Inexpensive static dissipating work mats are readily-available that will steadily and safely drain off any charges built up on parts or circuit boards placed on them. They are supplied with a lead that connects the mat to the common workbench ground. Also, metal cabinets on test equipment used on the bench should be tied together and connected to the common ground.

Most importantly, you must have a way of continuously draining off any static charges that occur on your body. Such charges are easy to create, even while sitting quietly at the work bench. Moving your feet on the floor, shifting position in your chair or even moving your arms so that clothing rubs against itself can all produce destructive static charges. You can discharge yourself by touching an unpainted metal ground, but that will last only until you move in a way that produces a new static charge. The safest technique is to wear a grounded wrist strap with a series 1-megohm resistor that continuously drains off any charges. Such wrist straps are readily-available and inexpensive.

WARNING

DO NOT attach a ground directly to yourself without a current-limiting resistor as this poses a serious shock hazard. A wrist strap must include a 1-megohm resistor to limit the current flow. If you choose to touch an unpainted, metal ground to discharge yourself, do it only when you are not touching any live circuits with your other hand or any part of your body.

We strongly recommend you take the following anti-static precautions (listed in order of importance) to avoid trouble:

- Leave ESD-sensitive parts in their anti-static packaging until you install them. The packaging may be a special plastic bag or the component's leads may be inserted in conductive foam. Parts which are

especially ESD-sensitive are identified in the parts list and in the assembly procedures.

- Wear a conductive wrist strap with a series 1-megohm resistor. If you do not have a wrist strap, touch a ground briefly before touching any sensitive parts to discharge your body. Do this frequently while you are working. You can collect a destructive static charge on your body just sitting at the work bench. **DO NOT attach a ground directly to yourself as this poses a serious shock hazard.**
- Use a grounded anti-static mat on your work bench.
- If you choose to use a soldering iron to work on your K3 for any reason, be sure the iron is ESD-safe with a grounded tip tied to the same common ground used by your mat or wrist strap.

Preparing for Assembly

Overview of the Kit

The kit comprises two major assemblies: the main chassis and the front panel. Figure 1 shows an assembled K3/10 with its top cover removed.

The main chassis is literally built up around the RF circuit board, which fills the entire bottom of the unit of the chassis assembly. Panels are mounted around the RF board using Elecraft's 2D fasteners. These fasteners allow individual removal of any one panel, if needed, to gain access to the inside of the radio for servicing. Very few cables or wires are used in the kit. Most of the other boards and optional accessories plug directly into the RF board or one of the boards mounted on the RF board.

The front panel assembly, including the display and main operator controls, includes the front panel board and the digital signal processing (DSP) board.

Of course, there are many options that you can add to the basic K3/10, such as the 100 watt amplifier module, internal antenna tuner, second receiver, additional crystal I.F. filters, etc. If you purchased these options with your K3 kit, you will find instructions to install them at proper places in the assembly procedure to make getting your complete K3 together and operational in the most efficient manner.

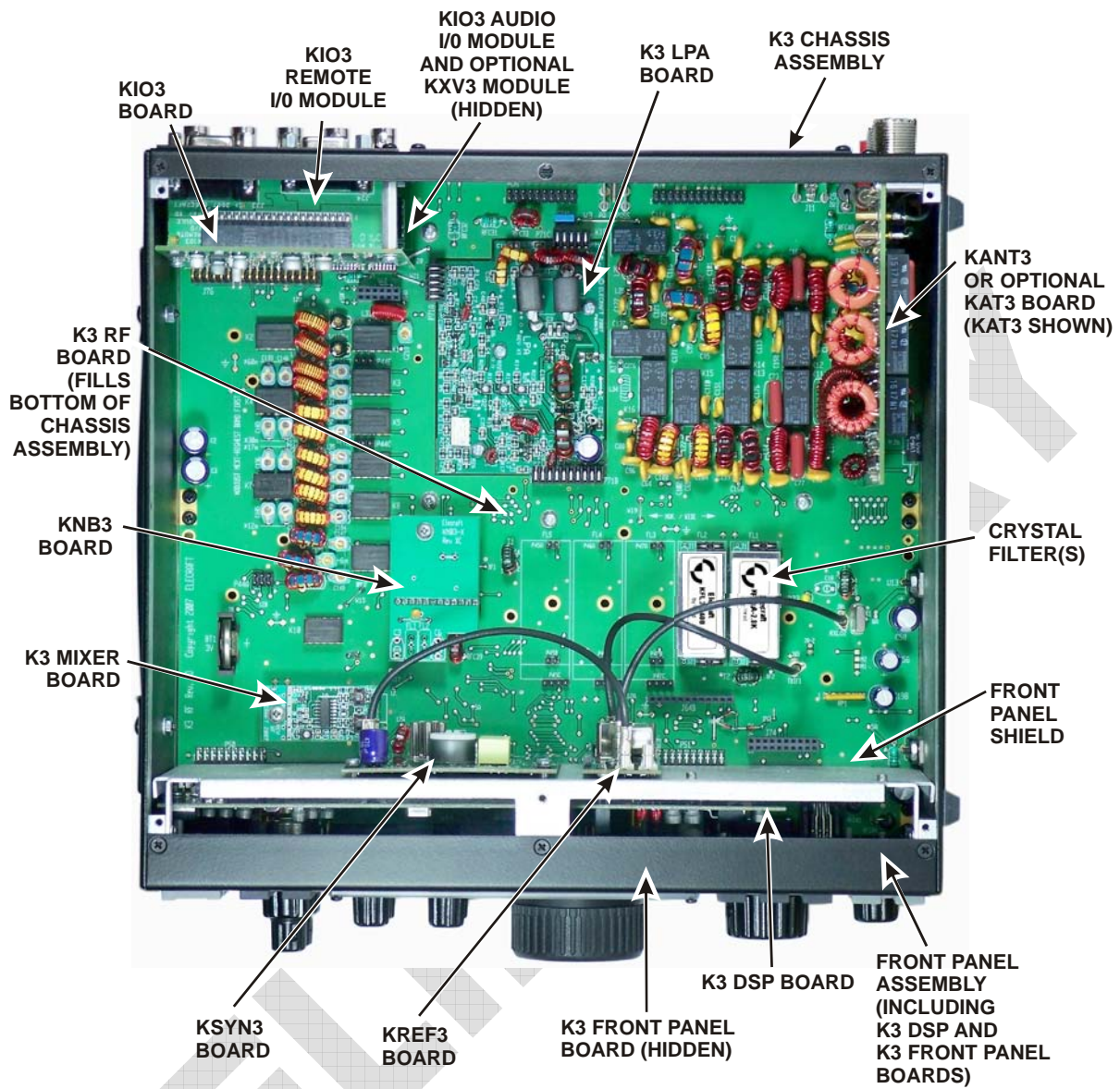

Figure 1. Assembled K3/10 (Less Top Cover).

PREVIEW

Tools and Test Equipment Required

1. #1 and #2 size Phillips screwdrivers. To avoid damaging screws and nuts, a power screwdriver is *not* recommended. Use the screwdriver that best fits the screw in each step.
2. Soft cloth or clean, soft static dissipating pad to lay cabinet panels on to avoid scratching. *If using cloth, do not lay circuit boards on it. See Preventing Electrostatic Discharge Damage on page 3.*
3. Nut driver or socket wrenches with screwdriver-type handle, 1/4", 3/16" and 1/2" sizes, are recommended. The 1/2" size is needed to tighten the nuts on the front panel controls. A deep socket or nut driver is required. An ordinary wrench can be used, but requires care to avoid damaging the front panel paint.
4. Allen wrenches, 5/64" (2mm) and .050"
5. Needle nose pliers.
6. Small ruler capable of measuring lengths up to 1" (2.5 cm) with an accuracy of at least 1/16" inch (1.6 mm).
7. Digital Multimeter (DMM) for voltage and resistance checks.
8. RF 50-ohm dummy load with low VSWR across the range of 160 meters through 6 meters.
9. Power supply 13 VDC nominal (11-16 V). A power cable is provided with your K3, You'll need to connect it to your supply: red wire to positive and black to negative.

The following tools are strongly recommended:

1. ESD wrist strap.
2. Static dissipating work pad.

Optional Equipment:

1. RF Power Meter with accurate readout from 1 mW to 5 watts, minimum.
2. Signal generator with calibrated 50 uV output at 20 or 40 meters.

Unpacking and Inventory

CAUTION

Do not handle the circuit boards without anti-static protection! Doing so may damage sensitive components. See *Preventing Electrostatic Discharge Damage* on page 3 for important information before proceeding.

Before starting construction, do a complete inventory to familiarize yourself with all of the parts and to ensure the kit is complete.

All dimensions given in the assembly procedure are provided in both US customary (often called English) and metric measurements. The native dimensions of the parts are in US Customary units. Approximate metric equivalents are given to assist those more familiar with that system to identify the correct parts.

Screws

A number of different types and sizes of screws and washers are used in the assembly. It is very important that you use the screw specified in each location or your finished K3 may not fit together properly. In some places, using the wrong size screw may damage components. The following table shows the various screw types and sizes specified in the text. Images are shown for comparing relative sizes. They are not to scale.











SCREW AS IDENTIFIED IN TEXT	RELATIVE SIZE (NOT TO SCALE)
2-56 1/8" (3.2 mm) BLACK PAN HEAD	
2-56 1/4" (6.4 mm) BLACK PAN HEAD	
4-40 3/16" (4.8 mm) BLACK PAN HEAD	
4-40 3/16" (4.8 mm) BLACK FLAT HEAD	
4-40 1/4" (6.4 mm) BLACK PAN HEAD	
4-40 1/4" (6.4 mm) ZINC PAN HEAD	
4-40 3/8" (9.5 mm) BLACK FLAT HEAD	
4-40 7/16" (11 mm) ZINC PAN HEAD	
4-40 1/2" (13 mm) BLACK FLAT HEAD	
6-32 1/2" (13 mm) BLACK PAN HEAD	

Figure 2. Screw Sizes Used in Assembly.

Standoffs

A number of threaded standoffs are used. As with the screws and washers, be sure you use the correct size as specified in the text. Standoff lengths are measured from end to end as shown in Figure 3. Standoffs threaded for 2-56 and 4-40 screws are used.

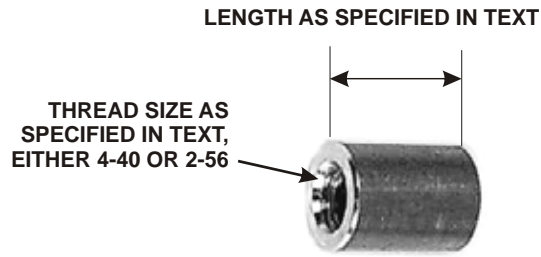

Figure 3. Typical Standoff.

Lock Washers

Two types of lock washers are used in the K3 (see Figure 4). It is important that you use only the type specified and put the washers exactly where indicated. Failing to use the correct type may result in short circuits to nearby circuit traces. Adding washers or placing the washers in the wrong position may cause parts to fail to fit together properly.



Figure 4. Lock Washers.

Assembly

IMPORTANT ASSEMBLY INFORMATION

1. Descriptions are included in each section for those who want to better understand the circuits. No assembly or test information is included in those descriptions. If you wish, you may skip over them and go directly to the assembly procedure in each section. **Note:** General circuit descriptions are provided in this manual. For additional details, including full schematics, please consult the K3 Service Manual.
2. A variety of screws and fasteners are used to assemble your K3:
 - Ensure all screws are tight, but do not over-tighten them. A loose screw can cause both mechanical and electrical problems such as intermittent operation, unexpected noise or false signals (birdies) in the receiver. Most of the screws are #4 size, which can be stripped if too much force is applied. Use of a power screwdriver is **not** recommended! Moderate torque applied using the correct-sized hand tools is all that's needed.
 - Use the correct length screws. In some cases using the wrong size screw can damage electrical and mechanical components. The proper size screw is called out in the procedure. Help identifying the screws can be found under on page 7.
3. Do not install options until you have completed assembly and verified normal operation of your basic K3/10. At various points in the procedure you will see instructions to install some hardware or other components for options you may have purchased that will make finishing their installation easier once your K3 is assembled. Do only those steps. Do not do any further installation of options before finishing and testing your K3/10.
4. Perform the assembly in the order given in this procedure. Checks and tests at points throughout the procedure assume you have completed all of the previous steps and only those steps. If you work out of sequence, you may get unexpected and erroneous results.

RF Board and Chassis

Circuit Description

RF Board

The RF PCB (Printed Circuit Board) is the heart of the K3 transceiver, both physically and electrically. During assembly, it serves as an attachment point for other PCBs as well as chassis panels, acting as the glue that holds things together. During operation, the RF board provides signal routing to and from all modules.

About 3/4ths of the RF board's components are surface mount devices (SMDs), located on the bottom side of the board. These are all pre-installed and tested at the factory. The use of SMDs minimizes stray coupling in RF circuits, reduces system cost, and allows the K3 to fit in a modest-size enclosure, compatible with home or field operation.

The RF board is divided into several functional areas. These can best be seen in the photo of Figure 12, and are described below. You may also wish to refer to the block diagram of the K3 shown in Appendix B.

Low-Pass Filters (LPFs): The relay-switched low-pass filters, used during both transmit and receive, are located in the back-right corner of the RF board. These filters can easily handle 100 watts, and are common to both the K3/10 and K3/100. Some LPFs cover one band, while others cover two bands that are close in frequency. The input to the LPF section comes from the KPA3 100-W amplifier module, if installed; if there's no KPA3, the input comes from the 10-W amplifier (see below). The output of the low-pass filters is routed through the forward/reflected power bridge, then on to either the antenna input module (KANT3), or the KAT3 automatic antenna tuner, which plugs in at far right.

Low-Power Amp (LPA) and T/R Switching: The large hole near the back-middle area of the RF PCB is where the 10-W low-power amplifier module plugs in. The LPA has three connectors that mate with the RF board, and its two power transistors attach to the rear bottom cover, which serves as a heat sink. This construction method allows the 10-W module to be tested separately during production. Also in this area is the T/R (transmit/receive) switch, but you'll need to turn the RF board upside down to see most of the components. The K3's T/R switch uses high-power, high-isolation PIN diodes rather than relays, resulting in no switching noise during keying.

Band-Pass Filters (BPFs): At back-left is the bank of ham-band BPFs. These filters are just wide enough to cover each ham band, so they provide good rejection of IMD products during both transmit and receive. Hi-Q components, including large toroids, ensure low loss and high signal-handling capability. General coverage receive capability can be added to the K3 with the KBPF3 option, which includes another 8 band-pass filters that cover all of the areas from 0.5 to 28 MHz that are not covered by the filters on the RF board. The KPF3 module mounts directly above the main BPF array, and due to very short connections, has no effect on the performance of the main BPFs during ham-band operation.

First I.F. Stages: The front-left portion of the RF board is dedicated to the receive/transmit first I.F. (intermediate frequency) circuitry, most of which is on the bottom of the board. The first I.F. is 8.215 MHz, which is low enough to permit the construction of high-quality, narrow-band crystal filters, but high enough to offer good image rejection. The I.F. stages are reversible; i.e., they're used in one direction in receive mode, and the other during transmit. In receive mode, the filtered signal from the BPFs is first routed through a relay-switched attenuator, then to a low-noise diode-switched preamp, high-level switching mixer, and post-mixer amp. The signal next encounters the noise blanker (KNB3), then the crystal filters (see below),

Crystal Filters and 2nd I.F.: In either receive or transmit mode, the I.F. signal is routed to one of up to five plug-in, 8.215-MHz crystal filters (FL1-FL5). These can be fixed-bandwidth, or in the case of FL3-FL5, optionally variable-bandwidth. Following the crystal filters is the receive I.F. and second mixer, which mixes the 8.215 MHz down to an I.F. of 15 kHz for use by the digital signal processor module (DSP). Excellent 2nd-I.F. image rejection is obtained by cascading an additional crystal filter just ahead of the second mixer. There's also a 15 kHz transmit I.F., which is mixed up to 8.215 MHz on the KREF 3 module, which plugs in near the front-middle of the RF board.

Support Circuitry: Several other modules plug into the RF board. The KPAIO3, located at the back edge of the RF board, is a vertically mounted board used as an interface between the RF board and the KPA3 100-W amp module. It provides current sensing, bypass relay, and other functions for the KPA3, and eliminates the need for any interconnecting cables. The KIO3 and KXV3, in the back left corner, provide RF, audio, and digital I/O. The main synthesizer, used for the main receiver as well as the transmitter, plugs in at front left and is attached to the front shield. To the right of this is the reference oscillator module (KREF3), as well as the second synthesizer, used for the subreceiver. These, too, attach to the front shield. The Front Panel/DSP module plugs in at the very front of the RF board. Finally, at the far right you'll find two low-noise linear voltage regulators, one for 5 volts and the other 8 volts. Both are heat-sinked to the right side panel.

LPA

The low-power amp module is capable of up to 12 W power output, and in the case of the K3/10, is the final amplifier stage. In the K3/100, it provides drive to the KPA3 module. The LPA has three gain stages, the last two of which use high-power MOSFET transistors to allow coverage up through 6 meters. At the input to the first gain stage is a 5-dB attenuator which is switched in under firmware control at certain power levels to optimize transmit gain distribution.

Noise Blanker

There are two noise blanker subsystems in the K3: the KNB3 module, and a DSP-based blanker (see *DSP* on page 26). The KNB3 is a narrow I.F. pulse blanker that plugs into the RF board. Its broad input bandwidth ensures minimum stretching of fast noise pulses, so it's ideal for suppressing noise from power lines, thunderstorms, and auto ignitions. The DSP blanker can be used on many other types of noise, including radar

and other noise with complex waveforms that would cause heavy intermodulation when an I.F. blanker was engaged. Using the two blankers in combination is often extremely effective.

The KNB3 includes a triple-tuned bandpass/time-delay filter, wide-range AGC, and a noise gate. You can think of the noise gate as a switch that is normally closed, allowing received signals to pass unimpeded. When a noise pulse appears, it is amplified to a high level and used to trigger a *one-shot* circuit. This opens the noise gate very briefly (from 5 to about 100 microseconds) to “blank” the noise pulse. Both the threshold at which blanking action occurs and the length of time the gate is opened are under control of the operator.

1st Mixer

The 1st mixer combines signals from the input band-pass filters with the output of the synthesizer to obtain the 1st I.F., at 8.215 MHz. The mixer is based on a video switching IC with very low ON resistance, resulting in low loss and high signal-handling capability. Since this type of mixer requires low drive, there’s very little leak-through of the local oscillator (synthesizer) signal. The mixer also incorporates a balanced VHF low-pass filter to suppress both internally and externally generated VHF/UHF spurs. This keeps the K3’s HF spur complement extremely low, despite the use of a down-conversion system architecture.

RF Board and Chassis Assembly Procedure

⚠ ESD SENSITIVE!

Observe ESD precautions when handling the circuit boards and whenever you are working on your K3 with covers off. Failure to observe ESD precautions may result in your K3 not operating at all, or operating but not meeting normal factory performance specifications due to damaged components. See page 3 for more information.

Remove the RF board from its anti-static packaging. The top side of the board is the side with the toroid inductors and relays along with other components, including several connectors along one edge. The edge with the connectors is the back edge of the board, while the front edge has notches cut in it that will fit around front panel controls. Locate the six rectangular bare copper pads for the 2D fasteners (see Figure 5). There is one in each corner of the board and one in the center of each side (see Figure 12 on page 14).

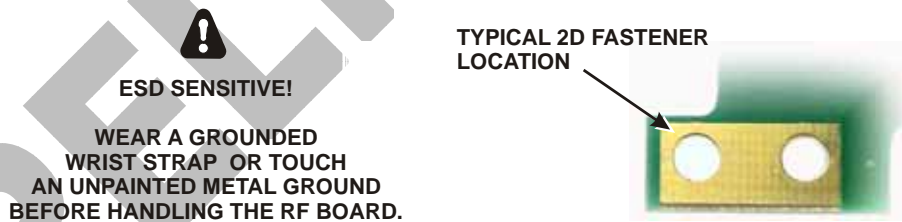

Figure 5. 2D Fastener Location on RF Board.

Install 2D fasteners at the six spaces provided (one at each corner and at the center of each side of the RF board). Mount the fasteners on the *bottom* side of the board as shown in Figure 6. Be sure the 2D fasteners are oriented so the side of each fastener lines up with the edge of the RF board as shown.

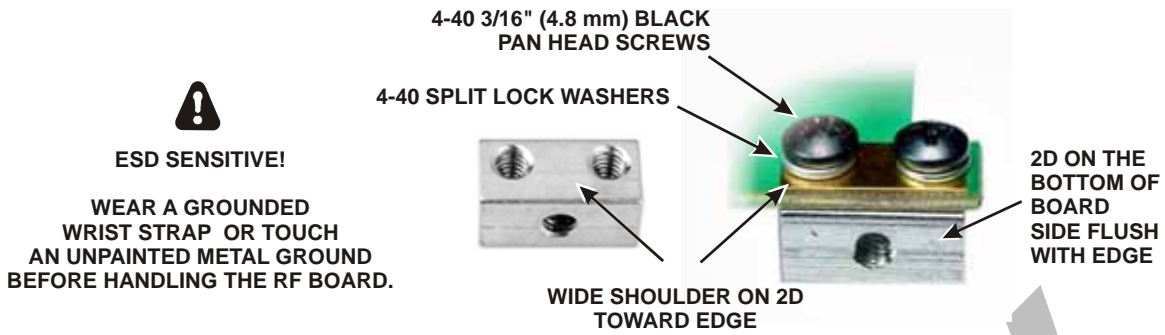

Figure 6. Installing 2D Fasteners on RF Board.

Install a standoff on the RF board near connector J77 as shown in Figure 7 below and Figure 12 on page 14. Use the hardware shown in Figure 8. Note that *two* lock washers are used as shown in the figure. This standoff will support the KNB3 noise blanker board to be installed later.

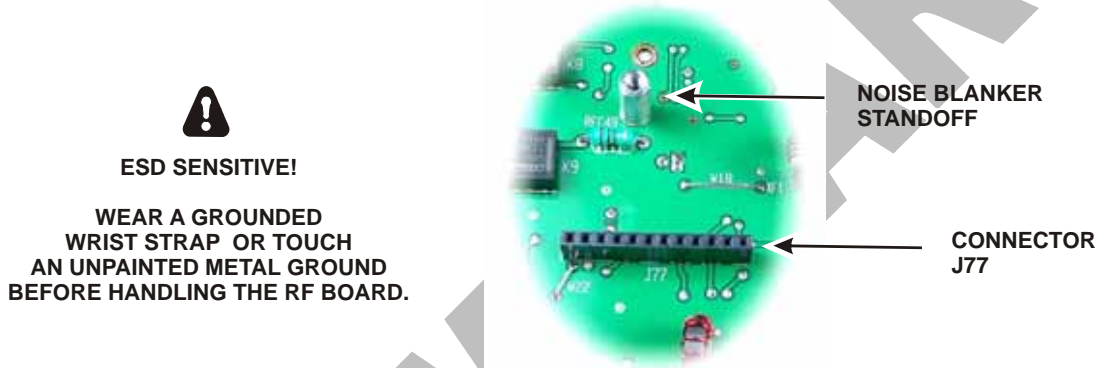

Figure 7. Noise Blanker Standoff Location.

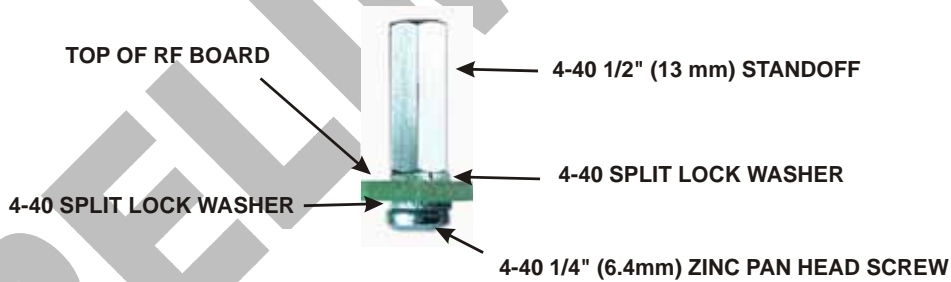

Figure 8. KNB3 Noise Blanker and KR MXR Mixer Standoff Hardware Installation.

Install a standoff on the RF board near connector Z1 as shown in Figure 9 below and Figure 12 on page 14. This standoff will support the mixer to be installed later. This standoff location is near the left front edge of the board. Install the standoff hardware using *two* lock washers as shown in Figure 8.

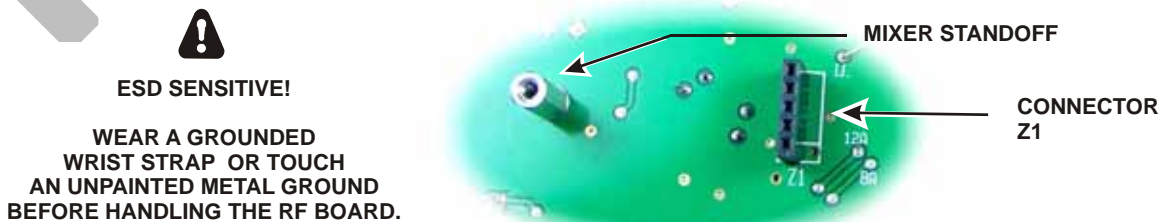

Figure 9. KR MXR Mixer Standoff Location.

Install hardware to attach the heat sink of Q3 to the RF board near the rear left corner as shown in Figure 10 and Figure 12 on page 14.

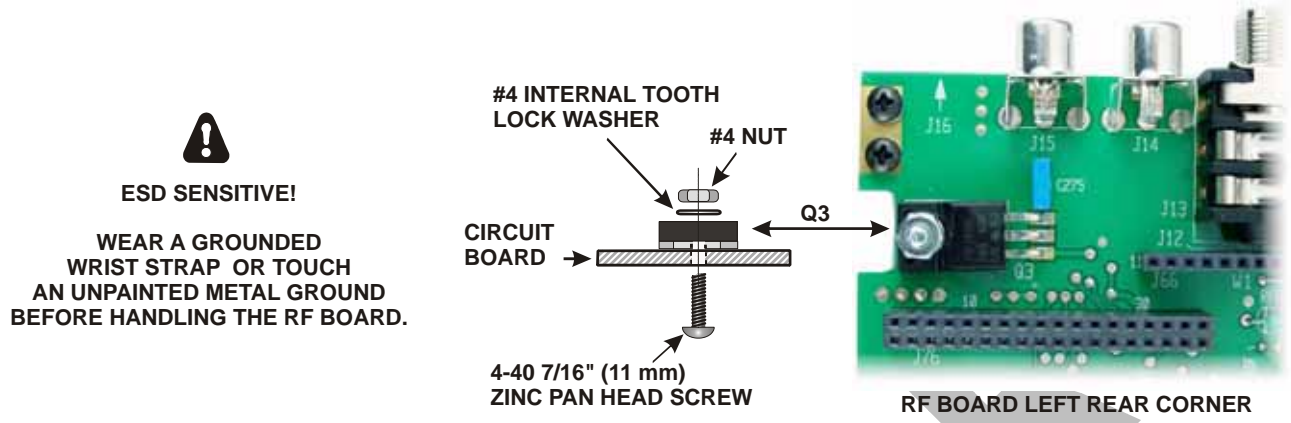

Figure 10. Installing Q3 Hardware on RF Board.

Install the crystal I.F. filters as shown in Figure 11, below, and Figure 12 on page 14. If you have more than one filter, install them with the widest bandwidth nearest the FL1 position. For example, 2.8 kHz and 400 Hz filters are shown. The 2.8 kHz filter is in position FL1 and the 400 Hz filter is in position FL2. If plan to add filters later, spaces may be left for them. For example, if you plan to add the FM or a 6 kHz AM filter later, you can leave spaces FL1 and FL2 open for them and install the 2.8 kHz filter in position FL3. The filters are not hard to move about later, so if you aren't sure, install the widest at FL1, the next widest at FL2 and so on.

CAUTION

- 1) Use screws no longer than 1/4" (6.4 mm) as specified. Use your ruler to measure the screws before installing them. Longer screws may extend into the filter unit and destroy it.
- 2) Do not over-tighten the screws. Too much torque may pull the threaded bushing out of the bottom of the filter module.

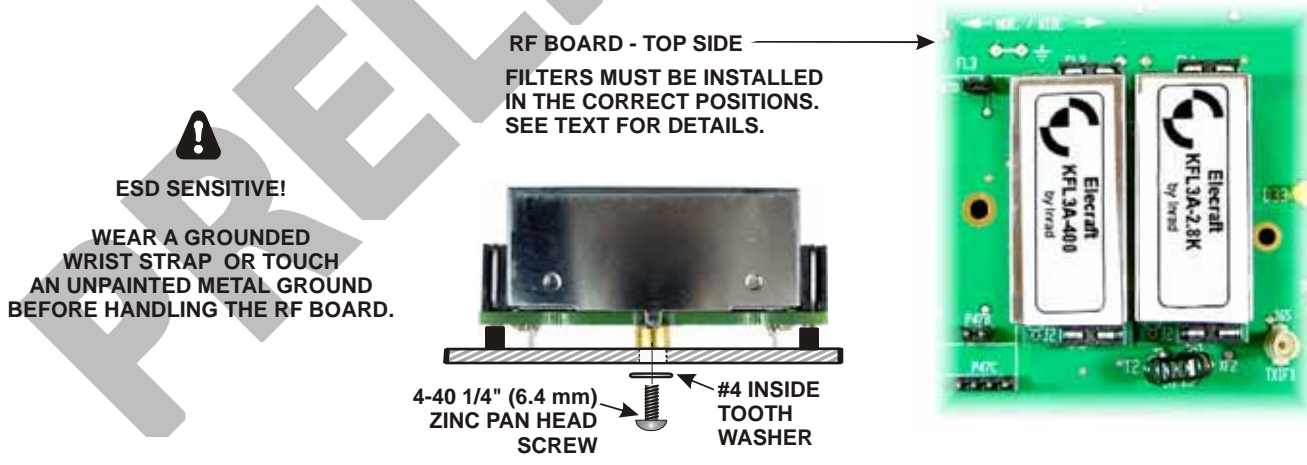

Figure 11. Installing Crystal I.F. Filters on RF Board.



ESD SENSITIVE!

WEAR A GROUNDED
WRIST STRAP OR TOUCH
AN UNPAINTED METAL GROUND
BEFORE HANDLING THE RF BOARD.

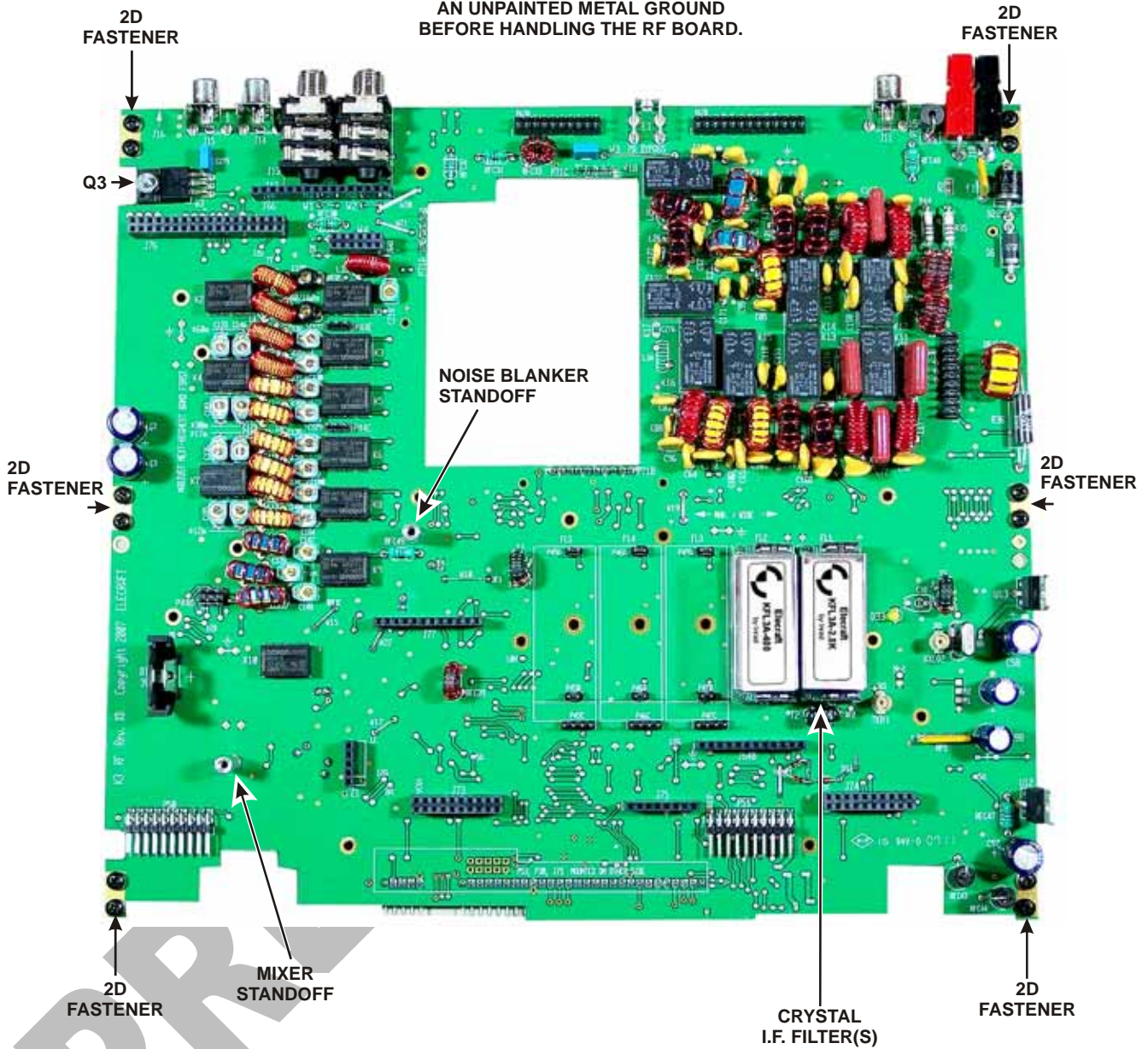

Figure 12. RF Board Partially Assembled.

□ Install the Low Power Amplifier (LPA) board in the cutout on the RF board as shown in Figure 13. The LPA board is held in place by its connectors until the bottom cover is installed..

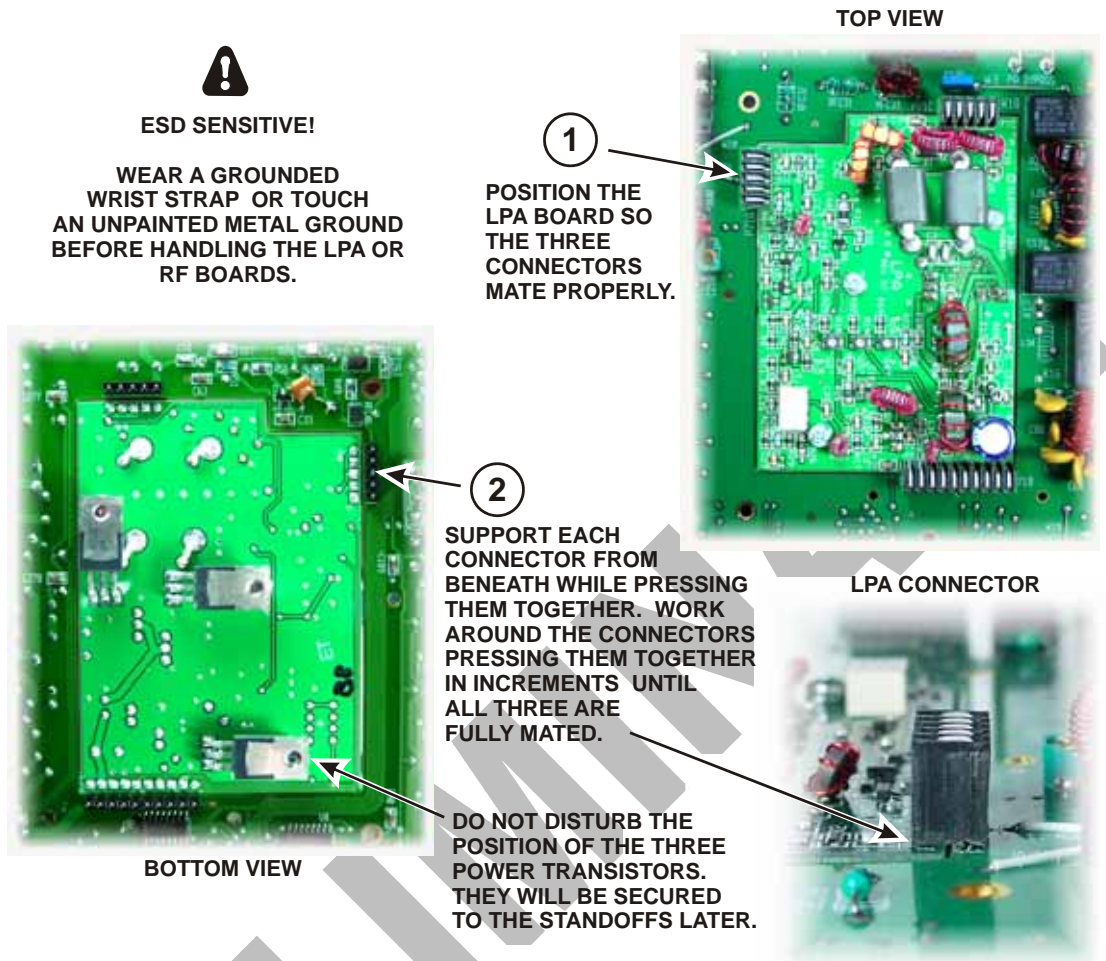

Figure 13. Installing the Low Power Amplifier (LPA).

PRELIMINARY

□ Mount the front panel shield on the RF board as shown in Figure 14, then mount a 2D fastener on each ear at the top of the shield as shown. Be sure the 2D fasteners are oriented with the widest part between the two holes and the edge toward the outside as shown.

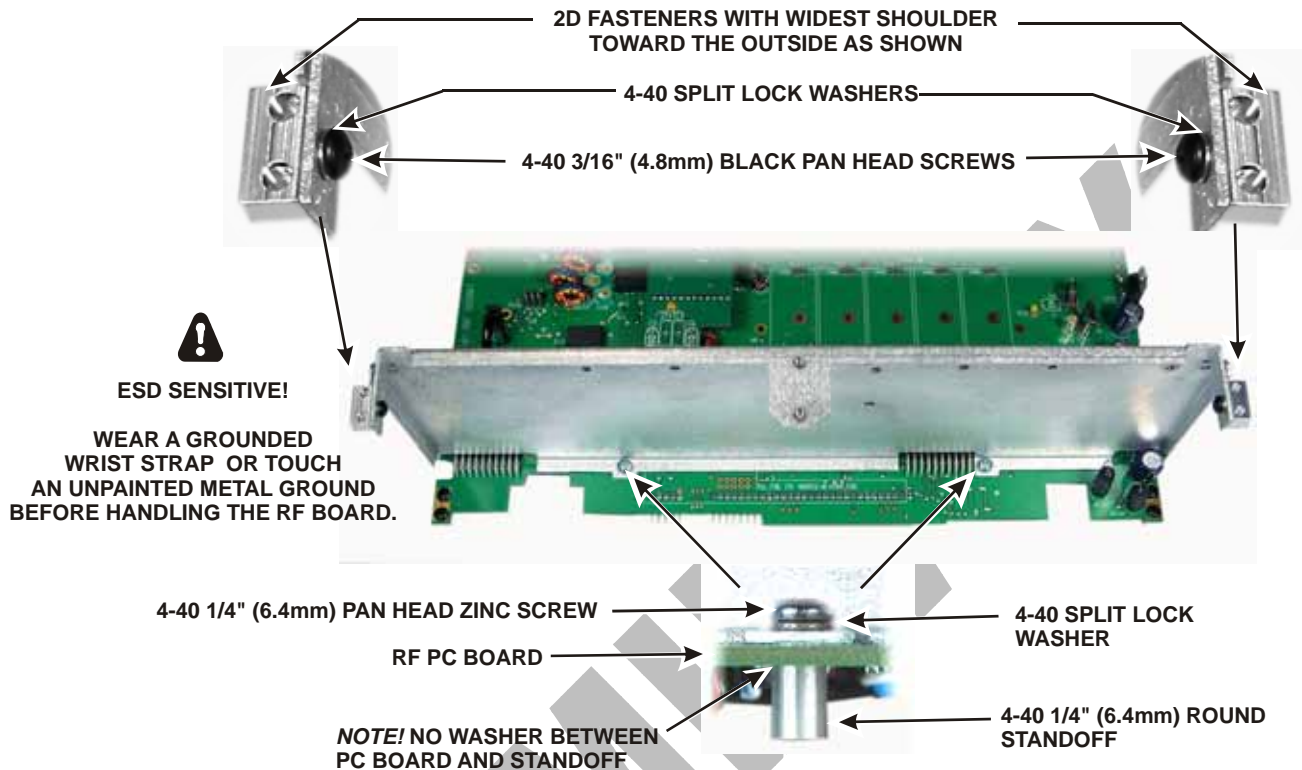

Figure 14. Installing Front Panel Shield.

□ Mount the KRMXR mixer and KNB3 noise blanker boards on the RF board as shown in Figure 15. The mixer plugs into Z1 and the noise blanker plugs in J77 on the RF board. When mounting the boards, do not try to mate the connectors fully. Mate the connectors only as far as necessary for each board to be parallel to the RF board when resting against its mounting standoff.

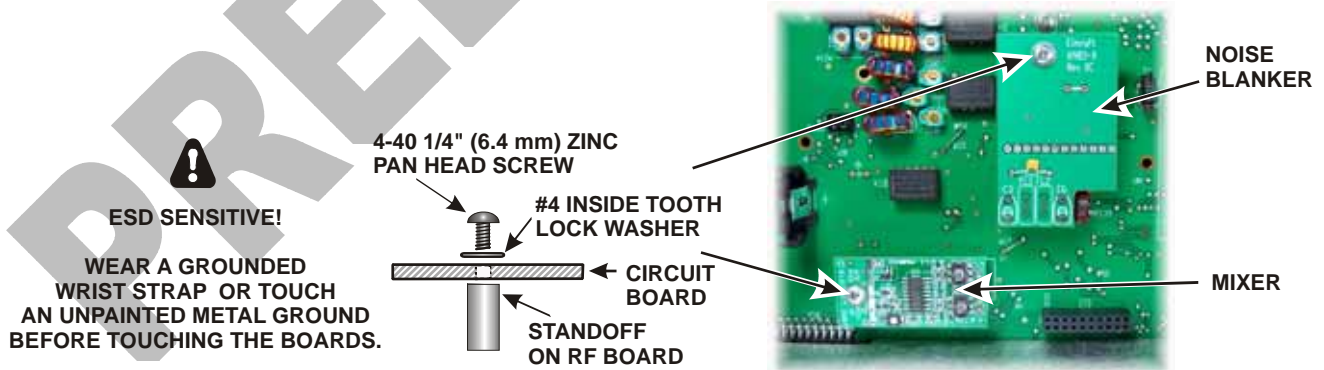

Figure 15. Installing KR MXR Mixer and KNB3 Noise Blanker Boards.

□ Locate the two side panels. They are approximately 4" (10 cm) by 9-7/8" (25 cm) in size. Both panels have six counter-sunk screw holes near the edges. Note that the countersunk holes are farther from one end than the other. This is important. You will need to orient the panels correctly in the following steps. The side panels are different as well. In addition to the six counter-sunk screw holes, the left side panel has two holes near the centerline for attaching the handle. The left side panel with the handle attached is shown in Figure 18. The right

side panel has six additional holes, four for mounting the side feet and two for attaching other parts inside the K3. The right side panel with the feet attached is shown in Figure 16.

Install the four rubber side feet in the holes in the right side panel as shown in Figure 16. Press each foot through the hole from the outside (the solid black painted side), then tug on the inside with your needle-nose pliers until the shoulder has opened on the inside of the panel to hold the foot securely in place.

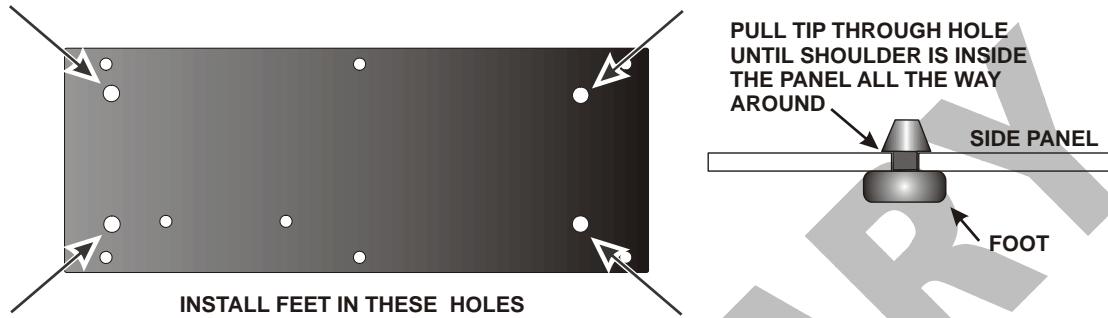

Figure 16. Installing Side Panel Feet.

Attach the handle to the left side cover using the hardware shown in Figure 17 at each end. Do not tighten the screws so much that you deform the handle end cover. The handle should move easily to allow room for your fingers between the handle and cover for carrying, then lie flat against the cover when it is not in use.

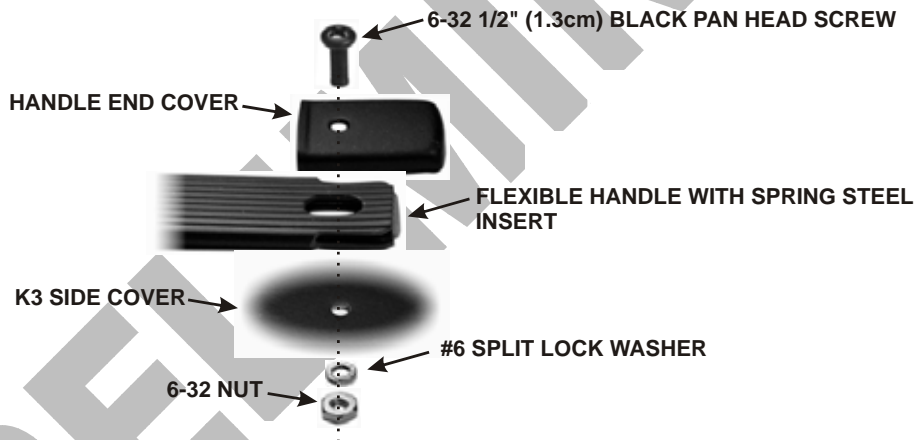

Figure 17. Installing Side Handle Mounting Hardware.

⚠ When installing the side panel in the next step, if the threaded holes in the 2D fasteners don't line up properly with the holes in the side panel, loosen the screws attaching the 2D fasteners to the RF board and front panel shield so they can move slightly to align the holes. Then retighten the screws after installing the side panel. Do this any time you find a 2D fastener is slightly out of alignment throughout the assembly procedure.

Attach the left side panel to the RF board assembly as shown in using four 4-40 3/16" (17mm) black flat head screws. Do **not** use washers. When the panel is oriented correctly, the edge of the panel will extend about 1/2" (13 mm) past the 2D fasteners at the right end of the RF board in the figure. If the threaded holes in the 2D fasteners don't line up properly with the holes in the side panels, temporarily loosen the screws attaching the 2D fastener to the RF board or front panel shield, then tighten them again after the side panel is installed.

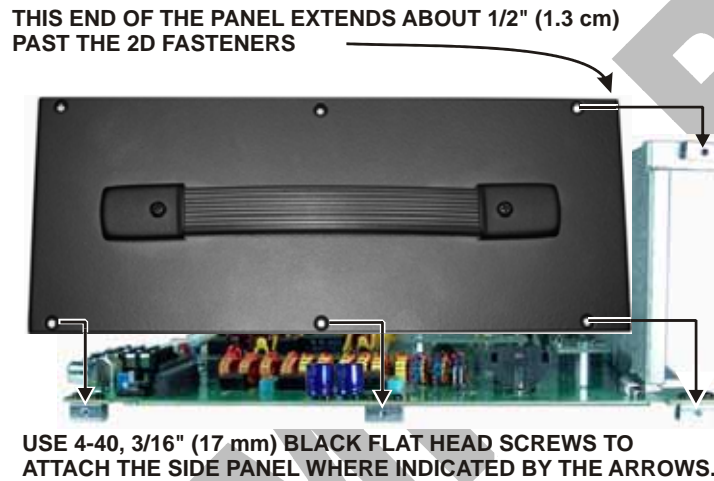

Figure 18. Mounting Left Side Panel.

Mount a 2D fastener at the top back corner of the side panel with a 4-40 3/16" (4.8 mm) black flat head screw as shown in Figure 19. Do **not** use washers. Be sure the 2D fastener is oriented correctly as shown in the figure.

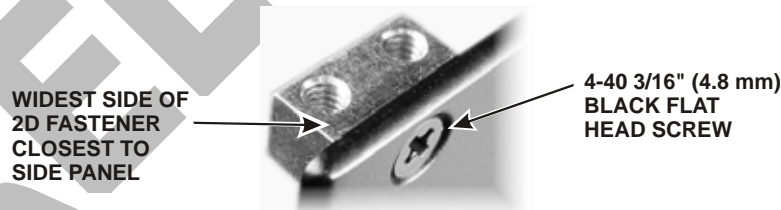

Figure 19. Installing Left Side Panel 2D Fastener.

Attach the right side panel to the RF board assembly just as you did the left side panel using four 4-40 3/16" (4.8mm) black flat head screws. Do **not** use washers. Be sure the panel is oriented so that about 1/2" (13 mm) of panel extends past the 2D fasteners at the same end as the left panel. Do not install a 2D connector on this panel yet. That will be done later.

☐ Attach voltage regulators U13 and U12 to the right side panel (the panel with feet attached) as shown in Figure 20 using a 4-40 3/8" (9.5 mm) black flat head screw, #4 inside tooth lock washer and a #4 nut for each regulator as shown. When the screws are tightened, the metal heat sink tabs on U12 and U13 should lie flat against the side panel.

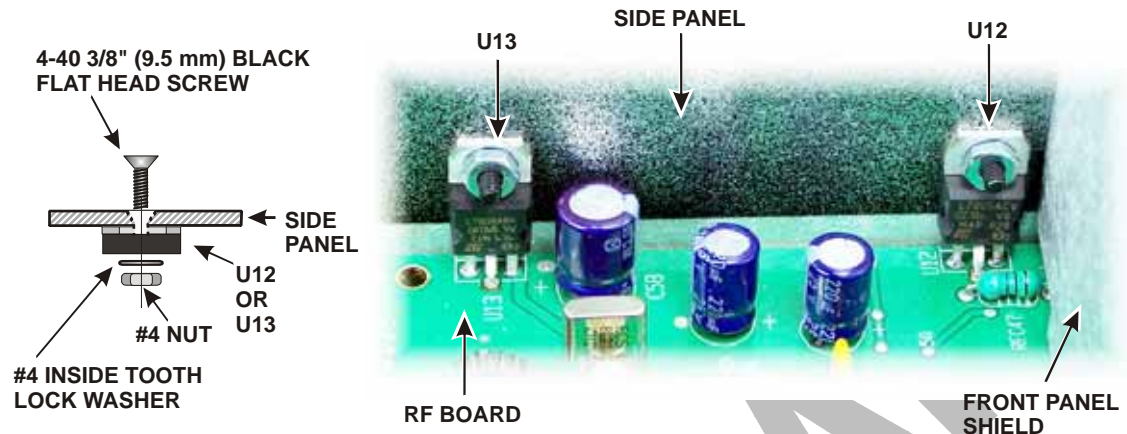

Figure 20. Attaching U12 and U13 to the Right Side Panel.

KANT3 or KAT3 and Rear Panel

⚠ If you purchased a KAT3 with your kit, you did not get a KANT3 board with your kit. For more information, see the *KANT3 AND KAT3 Circuit Description* below.

Circuit Description

The basic K3/10 includes a KANT3 antenna input module. If you've ordered a KAT3 antenna tuner, the KANT3 is not required and will not be supplied with the kit. In either case, the module plugs into the RF board at the back-right corner. Both the KANT3 and KAT3 provide antenna surge protection, as well as resistors for bleeding off static DC charge. The KAT3 provides a wide-range, switchable C-in/C-out L-network for matching a variety of antennas with SWR as high as 10:1 (100 W) or 20:1 (10 W). There are 8 inductors and 8 capacitors in the L-network, each switched with a DPDT relay for high reliability. The KAT3 also includes a second antenna jack and associated switching relay. There's an additional jack on the board for routing the unused (non-transmit) antenna to the KRX3 subreceiver module.

KANT3 or KAT3 and Rear Panel Installation Procedure

☐ Mount the SO239 connector in the ANT1 position on the rear panel using two 4-40 1/4" (6.4 mm) black pan head screws, two 4-40 split lock washers and two 4-40 nuts as shown in Figure 21.

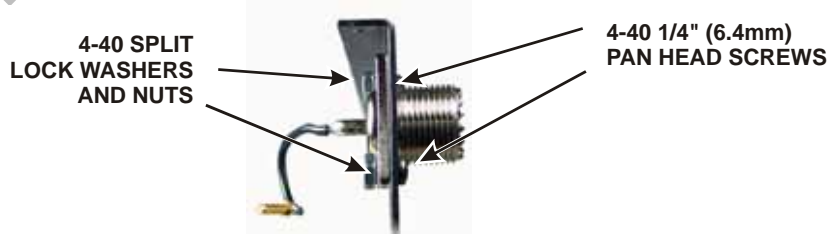

Figure 21. Mounting the ANT1 Connector.

☐ If you are installing the KAT3, install the second SO239 connector in the ANT2 position on the rear panel using two 4-40 1/4" (6.4 mm) black pan head screws, two 4-40 split lock washers and two 4-40 nuts just as you did for the ANT1 connector.

☐ Mount a 2D fastener on the inside surface at the top of the side panel above the red and black PowerPole® connectors on the RF board using a black 4-40 1/2" (13 mm) flat head screw as shown in Figure 22.

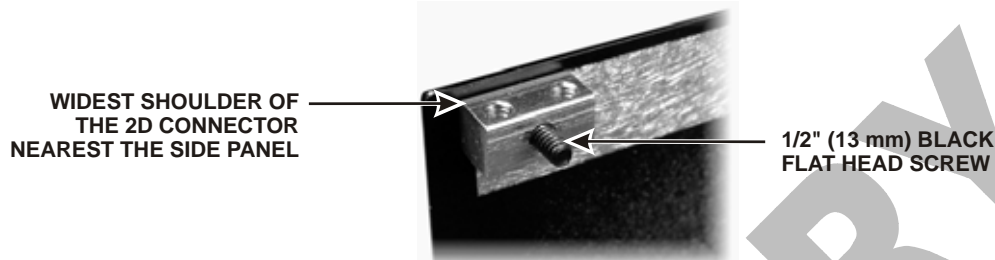

Figure 22. Mounting 2D fastener for KANT3 Standoff.

☐ Screw a 4-40 1/2" (13 mm) standoff onto the exposed end of the screw as shown in Figure 23. **Do not use a lock washer between the standoff and the 2D fastener.** Tighten the standoff securely against the 2D fastener.

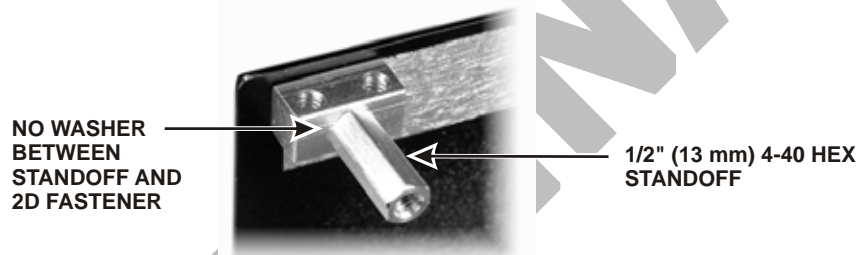

Figure 23. KANT3 Mounting Standoff.

☐ Insert J70 on the KANT3 or the KAT2 board into P70 on the RF board. The KANT3 board is shown in Figure 24. The KAT2 board fits exactly the same way. Make sure the connectors are fully mated, then secure the board to the standoff using a 4-40 1/4" (6.4 mm) zinc pan head screw. Place an inside tooth lock washer under the screw head. **Do not place a washer between the standoff and the board.**

ESD SENSITIVE!
WEAR A GROUNDED WRIST STRAP OR TOUCH AN UNPAINTED METAL GROUND BEFORE TOUCHING THE RF BOARD.

4-40 1/4" (64mm) ZINC PAN HEAD SCREW WITH 4-40 INSIDE TOOTH LOCK WASHER UNDER SCREW HEAD



KANT3 BOARD SHOWN. OPTIONAL KAT3 GOES HERE REPLACING THE KANT3.

BE SURE J70 IS FULLY MATED TO P70 ON THE RF BOARD

Figure 24. Installing the KANT3 or KAT3 Board.

® PowerPole is a registered trade mark of Anderson Power Products.

Position the rear panel on the K3 chassis assembly so that the holes in the corners of the top and bottom lips line up with the 2D fastener holes as shown in Figure 25. Secure the rear panel with a 4-40 3/16" (4.8 mm) black flat head screw at the top corners, and 4-40, 3/16" (4.8 mm) black pan head screws at the bottom corners. Retighten the side panel screws if you loosened them to position the rear panel. When secured, the end should fit snugly against the side panel at all four corners.

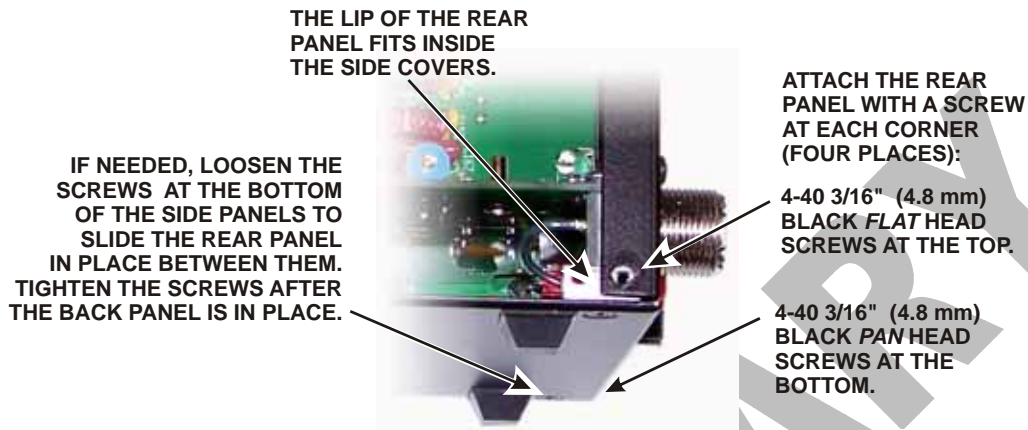

Figure 25. Installing the Rear Panel.

Connect the wires from the SO239 connector(s) to the KANT3 or KAT3 board as shown in Figure 26. Use needle-nose pliers to grip the terminals on the wire ends.

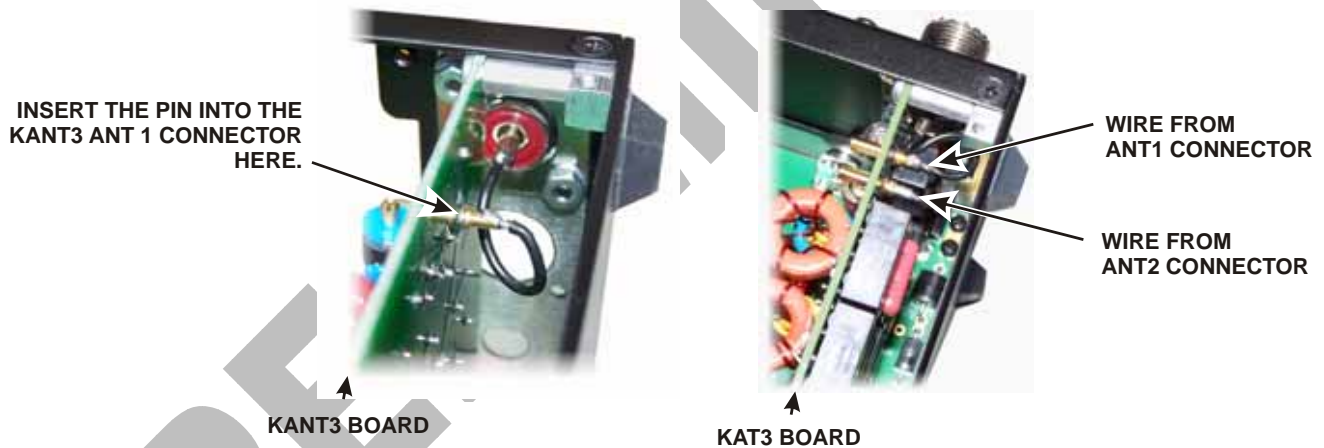

Figure 26. ANT Connections to KANT3 or KAT3 Boards.

If you installed the KANT3 board, the hole for the ANT2 jack is not used. Insert the larger of the hole plugs in the opening until it clicks in place (see Figure 27).

Insert the smaller hole plug in the AUX RF connector hole. Align the open side of the plug with the flat side of the hole as shown in Figure 27.

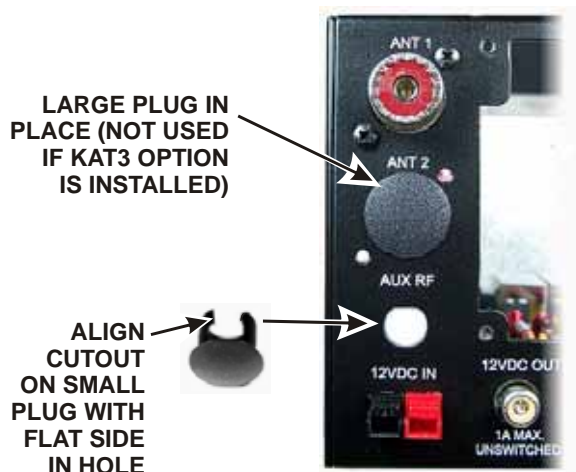

Figure 27. Installing Rear Panel Hole Plugs.

- Peel the backing from the self-adhesive serial number label and attach it to the back panel as shown in Figure 28.

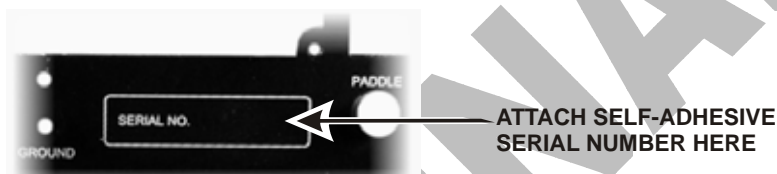

Figure 28. Attaching Serial Number.

- Install the 6-32 thumbscrew into the ground terminal position near the center of the rear panel as shown in Figure 29. Use two #6 flat washers between the thumbscrew and the back panel as shown.

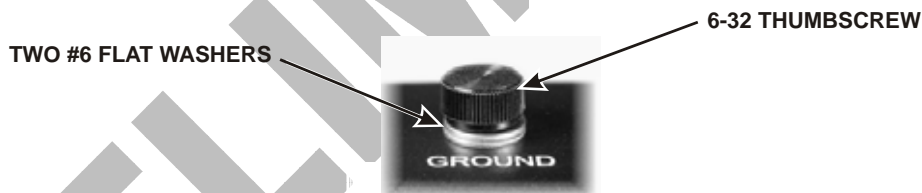

Figure 29. Installing Rear Panel Ground Screw.

KIO3 Interface

KIO3 Circuit Description

All audio and digital/computer I/O is routed through the KIO3. The KIO3 is made up of three PC boards: Main, Audio IO and Digital IO.

The Main KIO3 board plugs directly into the RF board. It includes a relay to disconnect the right speaker channel in case a mono speaker is plugged into the external speaker jack, isolation transformers for Line In and Line Out signals, a connection point for the internal speaker, a low-noise oscillator to provide voltages for the RS232 serial interface, and various control line inputs and outputs for external transverters, band decoders, and the like. This board also contains a differential output microphone amplifier to equalize the gain between the front and rear microphone jacks, as well as to provide noise immunity for the microphone signal from the rear panel area.

Circuitry to allow use of the serial port RTS or DTR signal lines as PTT and/or KEY inputs is also located on this board. This feature is to support logging and control programs which may use these lines for controlling transmit/receive switching or CW keying.

The Digital IO board plugs into the KIO3 Main board. It includes a DE-9 serial port connector for use with an external PC, and a DE-15 accessory connector for external band decoders (such as the KRC-2), transverters (such as the Elecraft XV-series), and similar devices. It is also the connector to which direct FSK or PSK signaling is applied.

The Audio IO board includes three stereo outputs: headphone jack, speaker jack, and a transformer-isolated Line Out jack. It also provides two monophonic inputs: microphone and an isolated Line In. The Microphone jack can provide bias for an electret microphone as a menu setting.

Both Digital and Audio IO boards include extensive bypassing and decoupling to help prevent RF signals getting into the radio from lines attached to their respective connectors.

KIO3 Interface Installation Procedure

If you have purchased the KXV3 option with your kit, go to the *Installation Procedure* in the KXV3 manual and install the option now, following the instructions in the *Special Note to K3 Kit Builders*. Otherwise mount the small blank panel in the space directly above PADDLE, KEY, PTT and KEY OUT connectors on the rear panel as shown in Figure 30.



DO NOT INSTALL IF YOU ARE INSTALLING THE KXV3 INTERFACE OPTION. SEE TEXT FOR DETAILS.

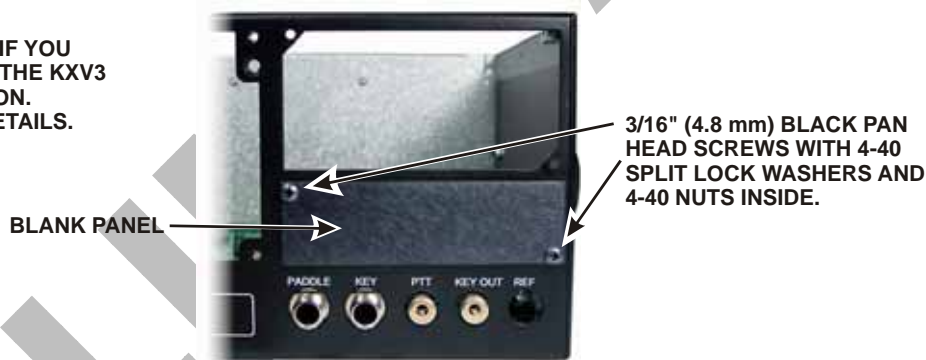

Figure 30. Preparing Rear Panel for KIO3 Installation.

□ Mount two 1-1/4" (31.8 mm) standoffs in the two holes at the corners of the of the KIO3 board as shown in Figure 31. **Do not put lock washers between the standoffs and the board.**

□ Plug the Audio I/O daughter board into J91 as shown in Figure 31. The second daughter board will be installed later.

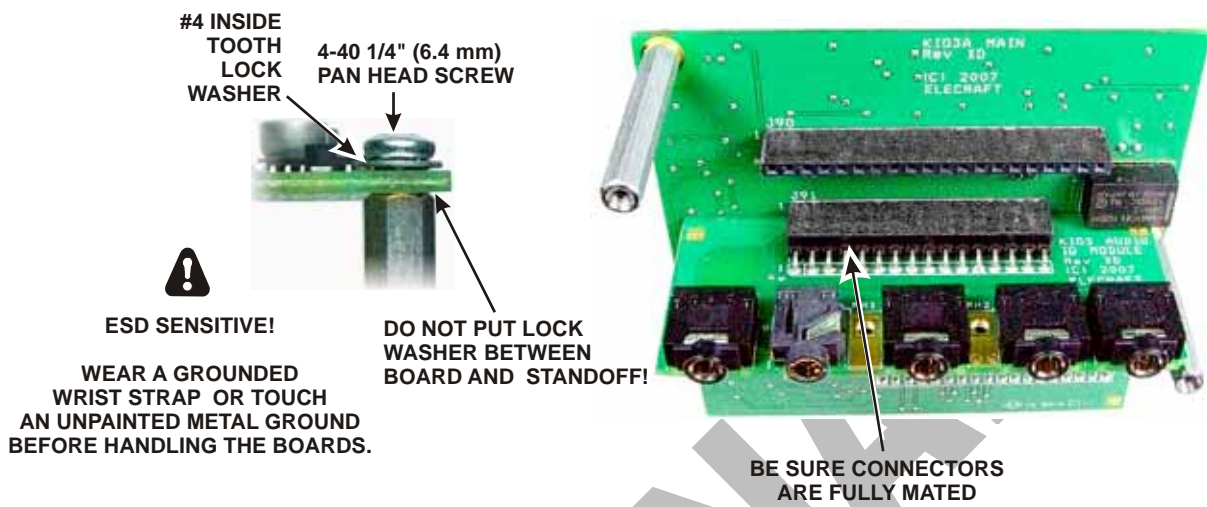

Figure 31. Preparing the KIO3 Board for Installation.

□ Install the KIO3 Main board with the Audio I/O daughter board attached into the K3 as shown in Figure 32. The KIO3A main board plugs into J76 on the RF board. Endure the connectors are fully mated so the standoffs line up with the screw holes on the rear panel.

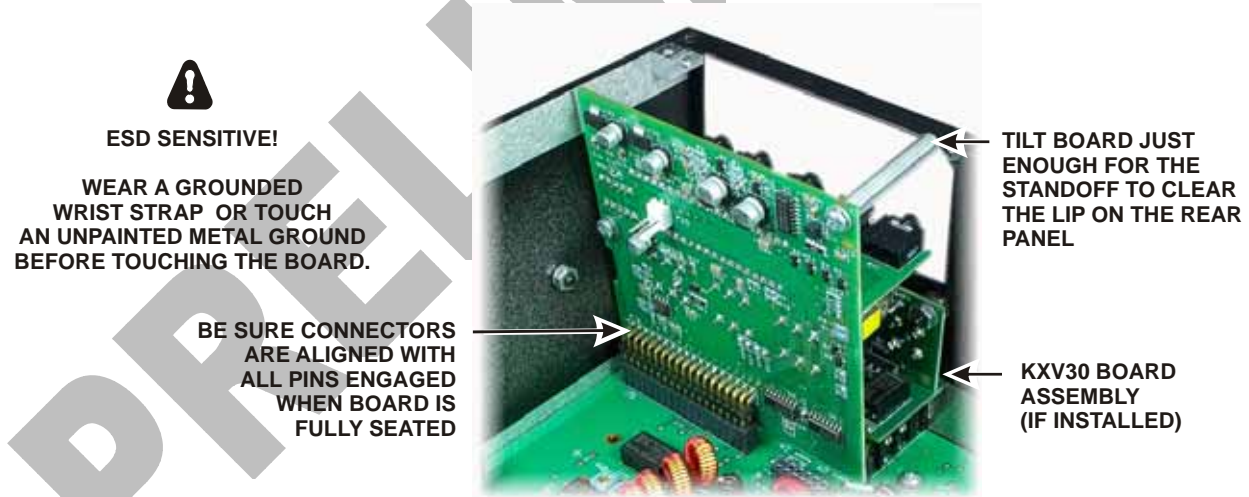

Figure 32. Installing KIO3 Main Board.

- Install the KIO3 Digital I/O daughter board as shown in Figure 33. Be careful to support the KIO3 main board as shown while pressing the daughter board in place.



Figure 33. Installing the KIO3 Digital I/O Board.

- Install the KIO3 rear panel as shown in Figure 34.

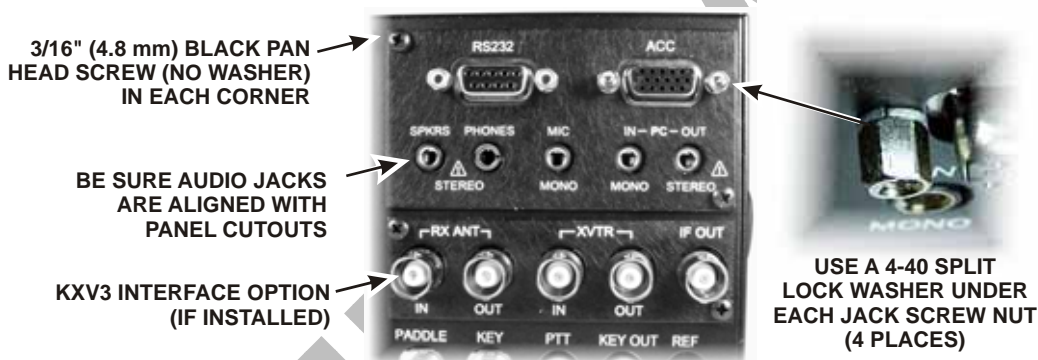

Figure 34. Mounting KIO3 Connector Panel.

Front Panel and DSP

Circuit Description

Front Panel

The Front Panel is a large plug-in module that provides the K3's user interface: 35 custom-labeled switches; two dual-concentric potentiometers for gain and squelch control; seven shaft encoders; custom, 240-segment, high-contrast LCD; and 13 discrete LED indicators. Mic and headphones can also be plugged into the front panel, or optionally at the rear panel (see KIO3 description, page 22).

The Front Panel module contains the Front Panel PCB assembly and the DSP assembly. The DSP is described later in this document.

The Front Panel PCB includes the microcontroller unit (MCU) which manages the operation of the K3. All inputs, whether from a button, switch, knob or external PC, are recognized and acted on by the MCU. All control outputs – such as switching from transmit to receive, sending a CW code element, adjusting the transmitter power, controlling LED brightness, etc. – are produced by the MCU.

The Front Panel also contains a large amount of flash and other memory. This allows the K3 to be re-programmed with the newest firmware by a simple download from the Internet. It also enables the K3 to remember your favorite settings, particular configuration preferences, and the last setting of most controls when power is removed from the radio.

DSP

The K3 is Digital Signal Processing (DSP)-based to enable it to provide a rich set of features to help combat QRM and QRN while at the same time generating some of the cleanest signals to be found in Amateur radio today. A 32-bit floating point DSP is used for highest performance.

In receive, a 15 kHz IF signal from the RF board is buffered and then digitized by a 24-bit Analog to Digital Converter (ADC). This provides over 100 dB of dynamic range within the passband of the selected roofing filter. After the ADC, the DSP converts the signal into a floating point value so dynamic range is not compromised during further processing. Noise blanking and limiting, AGC, amplification, IF and AF filtering are all done within the DSP. Several noise blanking algorithms (methods) are available in the DSP, and a sophisticated AGC system is employed. AM, FM, SSB and CW detectors are also implemented by the DSP. Various audio effects, such as Quasi-Stereo and Binaural, are provided here as well as combining the audio signals from the KRX3 if installed.

After processing, the resulting audio signals are generated in a stereo 24-bit Digital to Analog Converter (DAC) and applied to separate amplifiers for headphones (front and rear) and speaker. A separate DAC and amplifier provide Line Out signals that are not affected by the AF Gain control. This output is typically used by sound card digital mode software.

In transmit, Line In, rear or front Microphone signals are sent to a 24-bit ADC and then processed by the DSP. For speech modes (SSB, AM and FM), VOX is derived from these signals, as well as transmit audio. Microphone equalization, bandpass limiting, conversion to 15 kHz IF, envelope clipping and filtering (if applicable) are all done in DSP, then the signal is passed to a 24-bit DAC and presented to the RF board as a 15 kHz IF signal. Direct FSK, direct PSK and CW signals are generated within the DSP for those modes.

Thus, the DSP is responsible for all signal processing between audio and the 15 kHz IF for both receive and transmit. Like all other modules in the K3, the DSP is managed by the MCU.

The DSP board is piggybacked onto the Front Panel board as part of the Front Panel assembly. The Auxiliary DSP (used if the KRX3 Second Receiver Option is installed) and the KDVR3 option plug into the DSP board.

Front Panel Assembly Procedure



IMPORTANT ASSEMBLY INFORMATION

1. Install the standoffs and lock washers exactly as shown in the following steps. Note that the lock washers are placed between the standoffs and the board. This is very important for the boards to be positioned correctly.
2. Two different sizes of standoffs and screws are used. Be sure you use the hardware specified in each step.
3. Do not use inside tooth lock washers where split lock washers are specified. Inside tooth lock washers are slightly larger and may short nearby circuit pads on the more densely-populated front panel and DSP boards.

Remove the protective backing and mount the two self-adhesive pads in the corners on the back of the front panel board as shown in Figure 35. When removing the protective backing, be sure you do not pull the adhesive material off of the pad with the backing.

Mount three standoffs on the back of the front panel board as shown in Figure 35 . Place the lock washer between the standoff and board as shown.

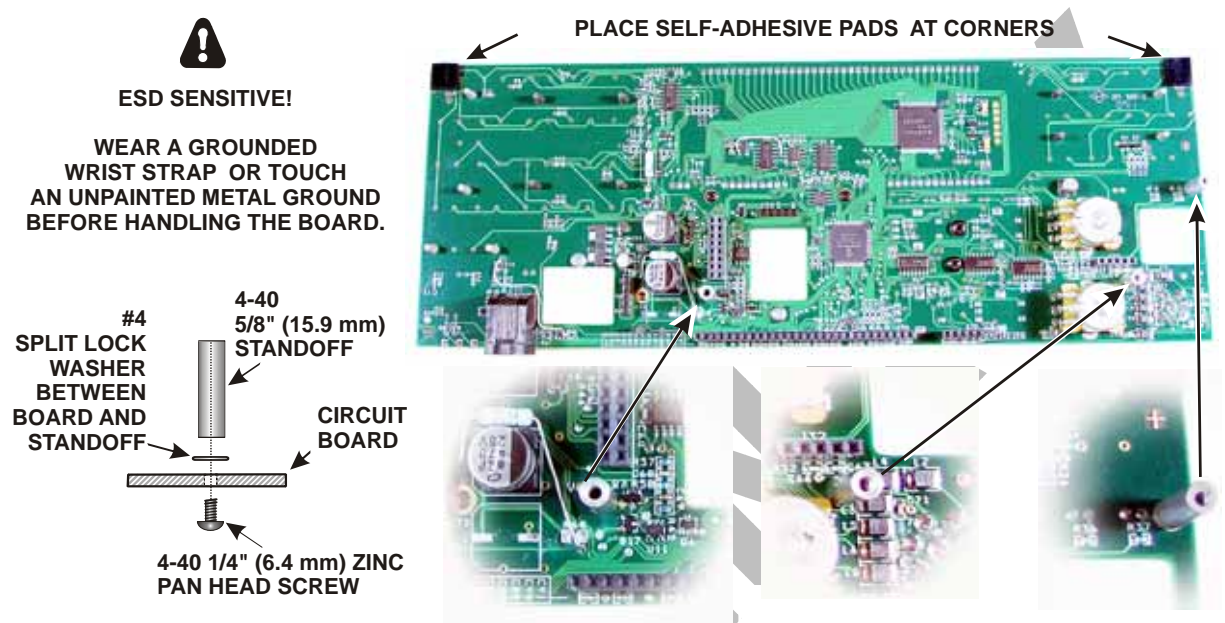

Figure 35. Preparing the Front Panel Board for Mounting, Part 1.

On the front side of the board, mount four standoffs as shown in Figure 36. Note that the two standoffs near the LCD panel use smaller #2 hardware as shown.

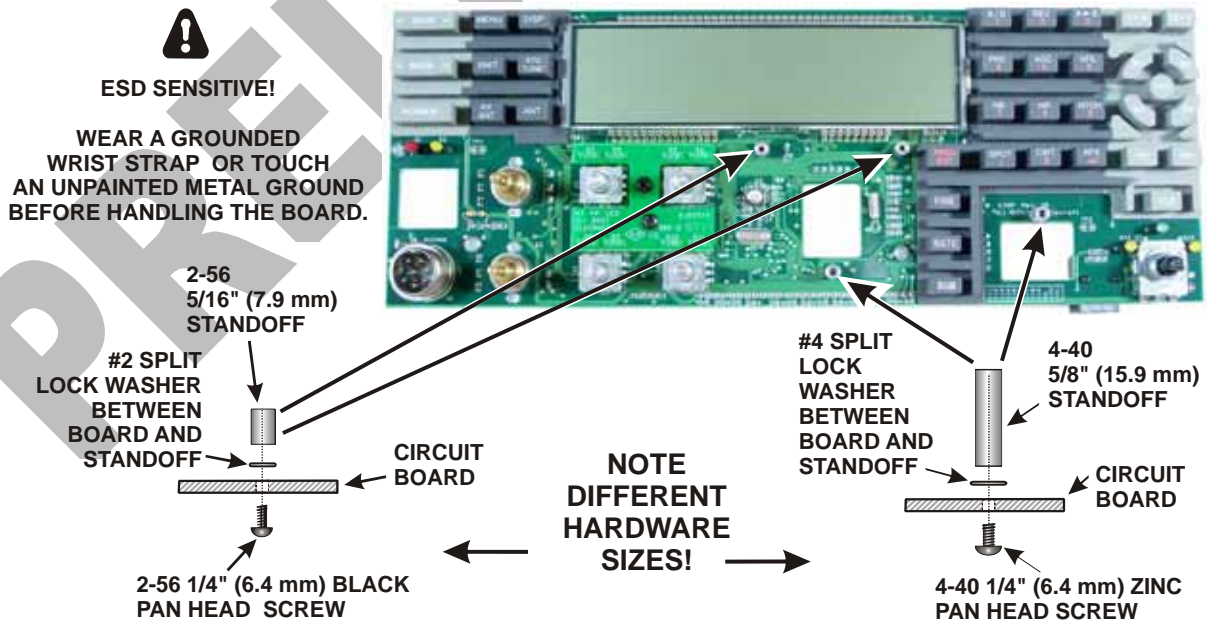

Figure 36. Preparing the Front Panel Board for Mounting, Part 2.

- ☐ Inspect the front panel board to verify the following:
 - Three 4-40 5/8" (15.9 mm) standoffs are mounted on the back as shown in Figure 35.
 - Two 4-40 5/8" (15.9 mm) standoffs are mounted on the front as shown in Figure 36.
 - Two 2-56 5/16" (7.9 mm) standoffs are mounted on the front as shown in Figure 36.

☐ Place the front panel board face up on your work surface, then set the front panel over it as shown in Figure 37. Secure the front panel to the board with a screw above the control opening near the right end and a 1/2" nut on the two concentric pots near the left end as shown. Tighten the screw and nuts only until you feel firm resistance with a screwdriver or screwdriver-type nut driver. **Do not over-tighten!** If you use pliers or another wrench on the 1/2" nuts, be very careful not to slip and scratch the front panel.

⚠
ESD SENSITIVE!
 WEAR A GROUNDED
 WRIST STRAP OR TOUCH
 AN UNPAINTED METAL GROUND
 BEFORE HANDLING THE BOARD.



Figure 37. Mounting the Front Panel on the Front Panel Board.

- ☐ Prepare the encoder assemblies as follows (See Figure 38). The encoders are identical except for the hardware added as shown.
 - Place a nut over the shaft of one encoder and screw it down against the shoulder as far as it will go. this will be the VFO B encoder.
 - Place a flat washer over the shaft of the other encoder. This will be the VFO A encoder.

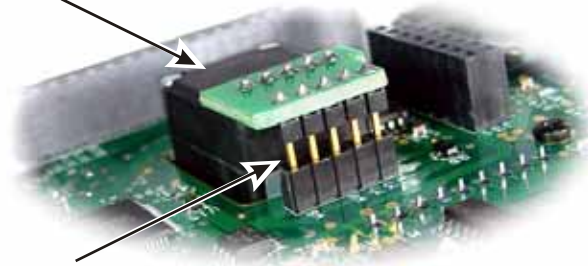

Figure 38. Preparing VFO Encoders for Mounting.

Place the VFO A encoder assembly (the one without the nut threaded on the shaft) in the opening near the center of the board so the shaft protrudes through the opening under the LCD. Orient the encoder so the pins mate with the connector on the front panel board as shown in Figure 39. Be sure the flat washer does not fall off. It must be between the inside of the front panel and the encoder. Note that the connectors do not fully mate. Part of the pins will be visible after it is installed.

!
ESD SENSITIVE!
 WEAR A GROUNDED
 WRIST STRAP OR TOUCH
 AN UNPAINTED METAL GROUND
 BEFORE HANDLING THE FRONT
 PANEL BOARD.

ENCODER FITS INTO FRONT PANEL
 BOARD CUTOUT UNTIL IT RESTS
 AGAINST THE INSIDE OF THE
 FRONT PANEL.



ENCODER PINS
 DO NOT FULLY
 MATE WITH SOCKET.

Figure 39. Mounting VFO Encoders.

Place a 3/8" (9.5 mm) nut on the threaded shaft of the encoder and tighten it against the front panel. Do not use a washer.

Place a second 3/8" (9.5 mm) nut on the encoder shaft under the LCD and tighten it against the nut you installed above (see Figure 40).

Mount the VFO B encoder assembly in the opening under the pushbutton switches on the right as you did above, using a single 3/8" (9.5 mm) nut. Be sure this is the encoder with the nut inside the front panel.

Locate the clear plastic LCD display cover and VFO A bezel. They may have an adhesive paper covering them for protection. If so remove it. If needed, wash the display cover and bezel in warm water with mild soap. Do not use harsh detergents or wiping with paper towels to avoid etching or scratching the surface.

Brush or blow any dust or lint away from the area of the encoder shaft under the LCD, then mount the trim panel as shown in Figure 40, oriented so the beveled edges are away from the panel. Tighten the screws only until they come into firm contact with the trim panel. **Be careful not to over-tighten the screws or you may break the trim panel.**

SECOND 3/8" (9.5 mm)
 NUT ADDED TO THIS
 ENCODER SHAFT ONLY

!
 DO NOT OVER-TIGHTEN
 SCREWS! DOING SO MAY
 BREAK THE TRIM PANEL.

4-40 3/16" (4.8 mm)
 BLACK FLAT HEAD
 SCREW



2-56 1/4" (6.4 mm) BLACK
 PAN HEAD SCREWS

BEVELED EDGE FACING
 AWAY FROM FRONT PANEL

Figure 40. Mounting VFO A Trim Panel.

Ensure the LCD cover is free of dust, smudges and fingerprints, then mount it over the LCD as shown in Figure 41 oriented so the beveled edges are away from the panel. Tighten the screws only until they come into firm contact with the trim panel. **Be careful not to over-tighten the screws or you may break the cover.**

 **DO NOT OVER-TIGHTEN SCREWS! DOING SO MAY BREAK THE COVER.**



Figure 41. Installing LCD Cover.

Place the larger of a pair of concentric knobs over the AF/SUB control as follows (See Figure 42):

- Turn both shafts fully clockwise.
- Place the larger knob over the shafts. Do not tighten the set screw yet.
- Place the smaller knob over the shaft, align its index line as shown in Figure 42 and tighten one set screw with a 0.05" Allen wrench.
- Rotate the larger knob so its index line is aligned with the index mark in the smaller knob, then lift it gently so it does not bind against the control bushing or the upper knob and tighten one set screw.
- Rotate both knobs about half way counter-clockwise and tighten the second set screw in each knob.
- Rotate the smaller and larger knobs over their entire range to see if moving one knob moves the other at any point in the rotation. If it does, loosen the set screws on the larger knob and move it slightly toward the panel until the knobs operate independently over their entire range of movement.

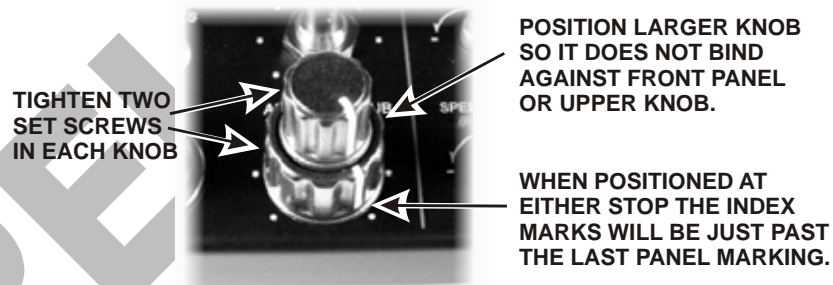

Figure 42. Mounting Concentric Knobs.

Place a pair of concentric knobs over the RF/SQL controls in the same manner as you installed the AF/SUB knobs.

☐ Press small knobs on the four controls under the left end of the LCD: SHIFT/LOW, HI/WIDTH, SPEED/IN and OUT/PWR. These knobs are all the same size. The four controls are encoders that rotate continuously, so the knobs have no index marks. The knobs are held in place by a friction spring as shown in Figure 43. Align the flat in the knob with the flat on each shaft before pressing each knob in place. In addition to the rotating encoder, each knob has a switch that is actuated by pressing the knob toward the panel. You will feel the switch action when you press each knob onto the shaft.

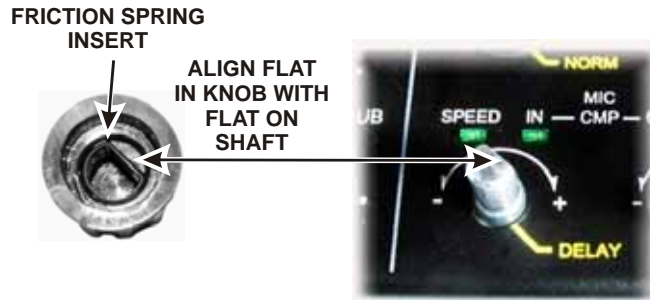

Figure 43. Mounting Friction Knobs.

- ☐ In the same manner, mount the slightly larger friction knob onto the RIT/XIT control in the lower right corner of the front panel. The RIT/XIT control does not have the switch action of the other four encoders.
- ☐ Mount the large knob on the VFO A encoder shaft below the LCD as shown in Figure 44.



Figure 44. Mounting the VFO A Tuning Knob.

□ Mount the last knob on the VFO B encoder shaft to the right (under the pushbutton switches) as shown in Figure 45. Note that this knob takes only *one* felt washer.

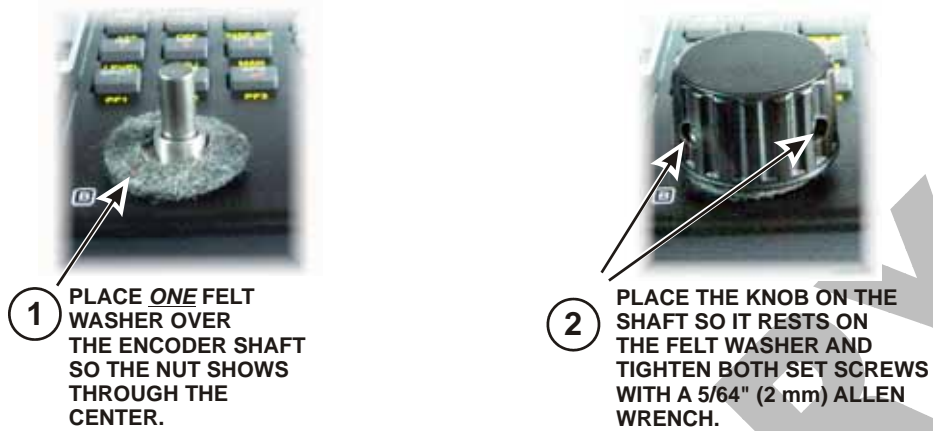

Figure 45. Mounting the VFO B Knob.

PRELIMINARY

Mount the DSP board on the front panel board as follows. When you are done, the front panel assembly will look like Figure 46.

⚠ ESD SENSITIVE: Wear a grounded wrist strap or touch an unpainted metal ground before touching the DSP or front panel boards.

- Place the front panel assembly face down on a soft, clean surface to protect the finish. The back side of the front panel board should be facing upward.
- Position the large flat washer on the inside of the front panel over the PHONES jack hole.
- Gently position the DSP board on the front panel board so that the large jack fits through the cutout in the front panel board with the threaded section passing through the large flat washer and the circular opening in the front panel. The three standoffs on the front panel board should line up with holes on the DSP board.
- Pick up the assembly and inspect the position of the two male plugs on the DSP board. They should mate with J31 and J32 on the front panel board. J31 is near the encoder for VFO A and J32 is between the two dual potentiometers. Adjust the DSP board's position as needed so the pins enter the corresponding holes in the sockets on the front panel board.
- Squeeze the boards together while ensuring the pins are mating with the connectors until the DSP board is resting against the three standoffs on the back of the front panel board that you installed earlier. The two connectors will not mate completely. Part of the connector pins will still be visible when the DSP board is resting against the standoffs. There are other connectors on the DSP board as well, but the two that mate with J31 and J32 are the only ones that connect between the front panel and DSP boards.
- Secure the DSP board to the front panel board with 4-40 1/4" (6.2 mm) zinc pan head screws and split lock washers as shown in Figure 46.

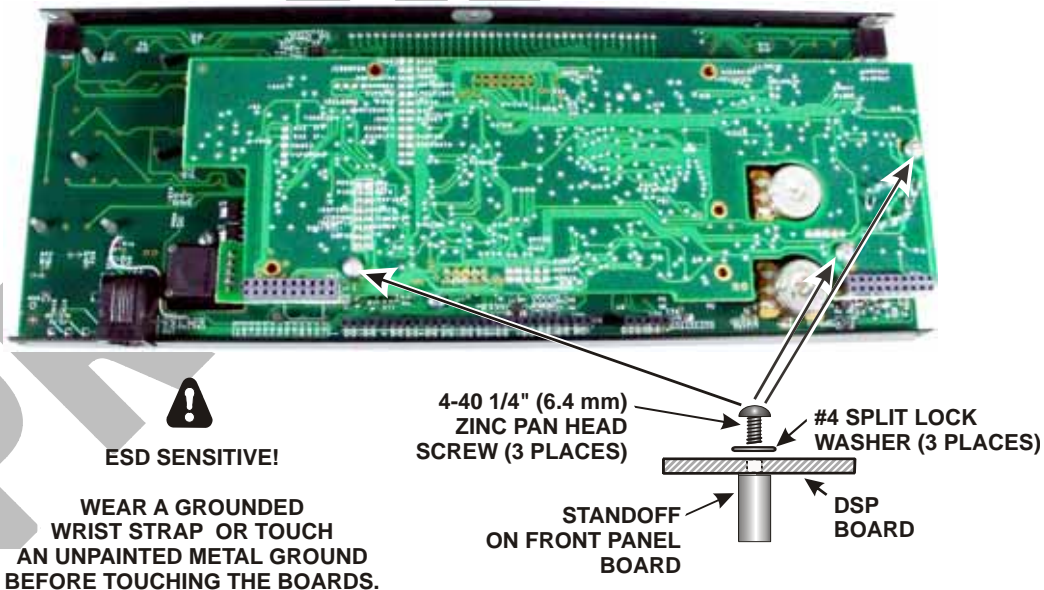

Figure 46. Mounting the DSP Board.

Screw the knurled nut onto the threaded shaft of the PHONES jack where it exits the front panel. Screw it only finger tight. Do not use pliers.

Mount the front panel assembly on the chassis assembly as follows (see Figure 47):

1. Place the chassis assembly upside down.
2. Loosen about 1/2 turn the screws holding the *bottom* 2D fasteners to the side panels. This will help the front cover slip into position between the side panels more easily.
3. Position the front panel assembly as shown so the pins on the four connectors are all mating properly.
4. Press the front panel assembly onto the chassis so that the connectors mate and the screw holes on both the top and bottom line up. If the assembly seems to stick as you try to push it into place, make sure the edge of the panel is sliding up over the edge of the 2D fasteners on the top and bottom corners.
5. Secure the front panel assembly to the chassis with three 4-40 3/16" (4.8 mm) black flat head screws on top and two 4-40 3/16" (4.8 mm) black pan head screws on the bottom.
6. Tighten the side panel screws holding the bottom 2D fasteners that you loosened in step 2.

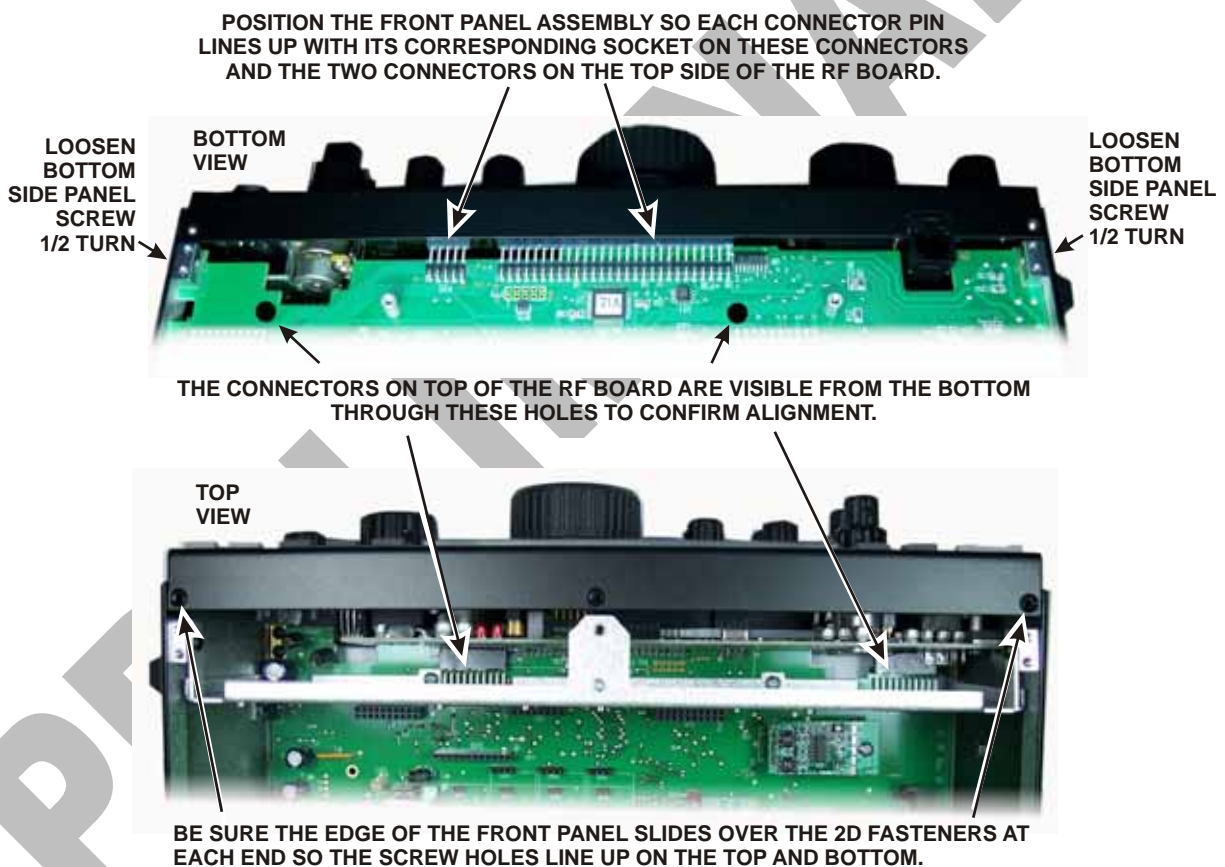

Figure 47. Mounting the Front Panel Assembly on the Chassis.

Resistance Checks

The following resistance checks confirm that the main power busses in the K3 aren't shorted to ground somewhere. If any of the values measured are lower than specified, inspect the unit carefully for loose hardware that is caught between components on the boards or for improperly mated connectors.

Use your DMM to measure the resistance across the red and black 12VDC IN connectors on the rear panel. The resistance shall be greater than 50K ohms. It may be much higher, depending upon which way you connect

the leads. Your DMM may indicate the value is so high it is out of the range of the instrument and your meter may display something like OR or simply remain blank, as it does when in ohms mode and the probes are not touching anything. If you are not sure, refer to your DMM's instruction manual to interpret the reading.

- Use your DMM to measure the resistance between the end of R36 and ground (see Figure 48). The resistance shall be greater than 150 ohms.

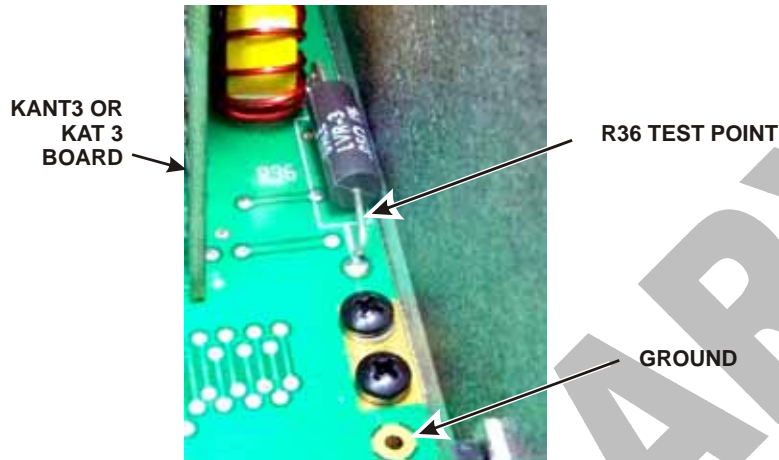

Figure 48. R36 Test Point.

- Use your DMM to measure the resistance between the terminal on U12 and ground shown in Figure 49. The resistance shall be greater than 500 ohms.
- Use your DMM to measure the resistance between the terminal on U13 and ground shown in Figure 49. The resistance shall be greater than 150 ohms.



Figure 49. U12 and U13 Test Points.

Initial Power On Check

The following check confirms that the power supply and power control circuits are working properly. Be sure your K3 passes the resistance tests above before proceeding.

⚠ CAUTION!

If you see or smell smoke when applying power, turn the K3 off and remove the power cable immediately, then locate the source.

- Connect your 13.8VDC power supply to the 12VDC IN connector on the rear panel. Do not connect a key, microphone or other accessories to the K3 at this time.

Tap the front panel **POWER** button and confirm the LCD display lights. Some front panel LEDs may light as well, and you may notice D33 on the RF board, next to the crystal filters, light. Ignore any error messages on the display and do not try to operate the radio at this time. You'll get to do that soon.

Tap the front panel **POWER** button again to turn the K3 off and disconnect your external power supply.

KREF3

Circuit Description

The KREF3 module's 49.380-MHz temperature-controlled crystal oscillator (TCXO) is the common signal source for the K3's synthesizers. This signal is also divided by 6 to provide the 8.230-MHz signal used by the second receive and transmit mixers. Firmware is used to compensate for any small drift in the TCXO and its derived signals, resulting in excellent stability (with the high-stability option, better than +/- 0.5 PPM over the 0 to 50 C temperature range). In addition to the TCXO and dividers, the KREF3 provides the 2nd transmit I.F. mixer, which mixes the DSP's 15-kHz transmit I.F. output up to 8.215 MHz. This signal passes through a wide crystal filter to ensure good rejection of the carrier and other mixer products before the TX I.F. is routed to the RF board. The KREF3 obtains its DC and low-frequency I/O signals via an 8-pin connector to the RF board, but its RF outputs are fed to the RF board (and subreceiver, if applicable) via coax cable assemblies.

KREF3 Installation Procedure

Install the KREF3 board on the back side of the front panel shield as shown in Figure 50. The KREF3 board plugs into J75 on the RF board. Be sure you have the KREF3 board connector aligned with J75 so that all the pins mate with the connector.

ESD SENSITIVE!
WEAR A GROUNDED
WRIST STRAP OR TOUCH
AN UNPAINTED METAL GROUND
BEFORE HANDLING THE BOARD.

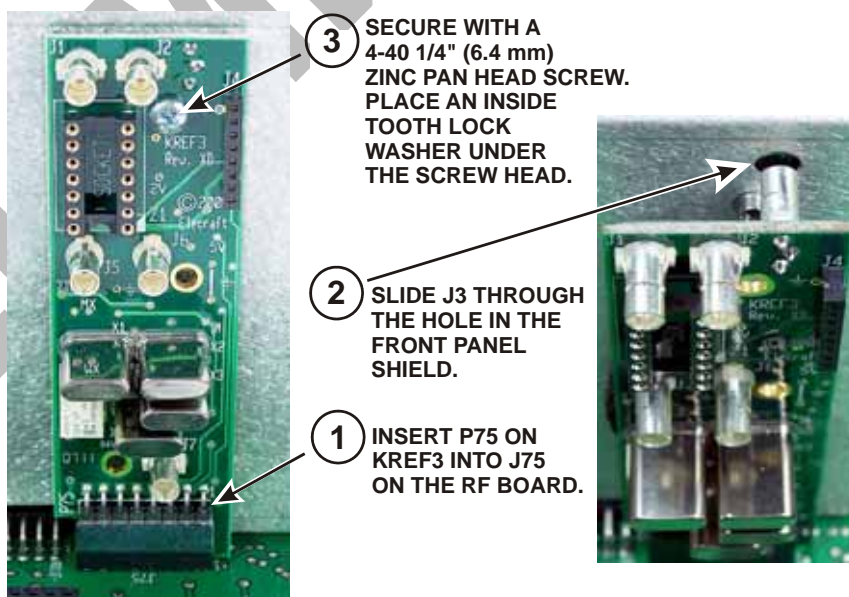

Figure 50. Installing KREF3 Board.

□ Install Oscillator module in socket Z1 on the KREF3 board as shown in Figure 51. Be especially careful to ensure all four pins go into the corner holes in the socket and that the black dot on the oscillator is at the corner nearest J6.

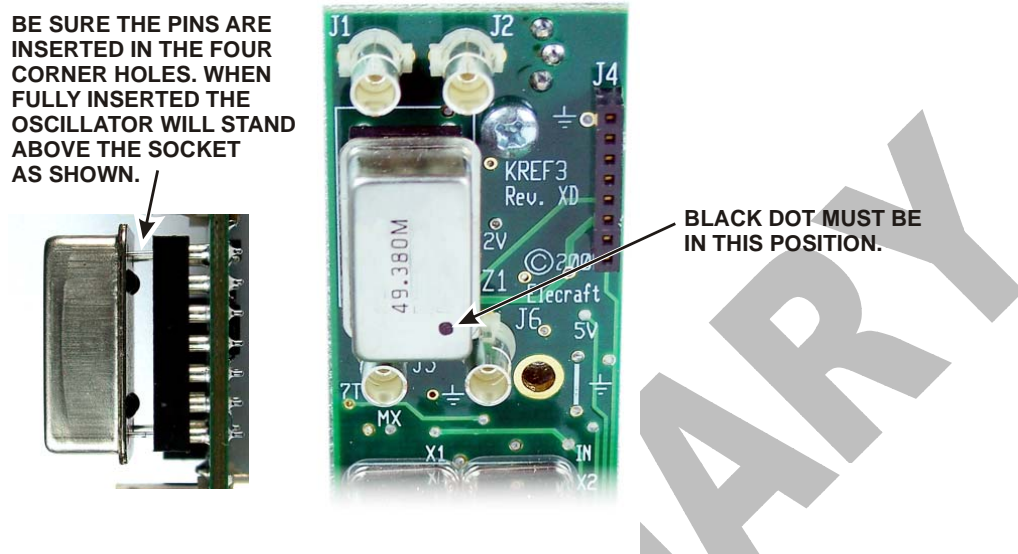

Figure 51. Installing KREF3 Oscillator Module.

KSYN3

Circuit Description

Low phase noise is key to both receiver and transmitter performance. In the K3's synthesizer module (KSYN3), we start with a clean, wide-range voltage-controlled oscillator (VCO). The VCO is placed near the desired band of operation using 128 carefully-selected L-C combinations, which keep the ratio of fixed capacitance to tunable capacitance (varactor diodes) as high as possible.

The VCO is held exactly on frequency by a phase-locked-loop IC (PLL), which samples the VCO output continuously and compares it to its high-stability reference input. The PLL's reference input is obtained from a direct-digital-synthesis IC (DDS), which is tunable in about 0.2-Hz steps, and has as its reference the 49.380-MHz signal from the KREF3 module.

To keep the synthesizer's output signal spur-free, the DDS is followed by a +/- 1.2 kHz, 4-pole crystal filter, which eliminates both directly-occurring spurs and the Nyquist sampling spurs that normally accompany a DDS-driven PLL system. As you tune the VFO, the K3's firmware continuously recalculates the exact DDS frequency needed. When the end of the crystal filter's range is reached, the PLL's VCO and reference dividers are updated to a new value. A computer was used to create the table of divider values for the PLL, optimizing for fewest possible divider changes within ham bands. On 20 meters, for example, these changes occur only every 15-20 kHz, even though the DDS only covers a 2.4 kHz range. The combination of all of these noise-minimization techniques results in both very low phase noise and minimal discrete spur content.

KSYN3 Installation Procedure

☐ Install the KSYN3 board on the back side of the front panel shield as shown in Figure 52. The KSYN3 board plugs into J73 on the RF board. Be sure the connectors are aligned so that all the pins go into the corresponding socket holes on J73.

② SECURE WITH 4-40 1/4" (6.4mm) ZINC PAN HEAD SCREWS. PLACE AN INSIDE TOOTH LOCK WASHER UNDER EACH SCREW HEAD.



ESD SENSITIVE!

WEAR A GROUNDED WRIST STRAP OR TOUCH AN UNPAINTED METAL GROUND BEFORE HANDLING THE BOARD.



① INSERT P73 ON THE KSYN3 BOARD INTO J73 ON THE RF BOARD.

Figure 52. Installing the KSYN3 Board.

☐ Locate the three TMP cables. They are 1/4" (6.4mm) diameter coaxial cables with connectors at each end as shown in Figure 53.

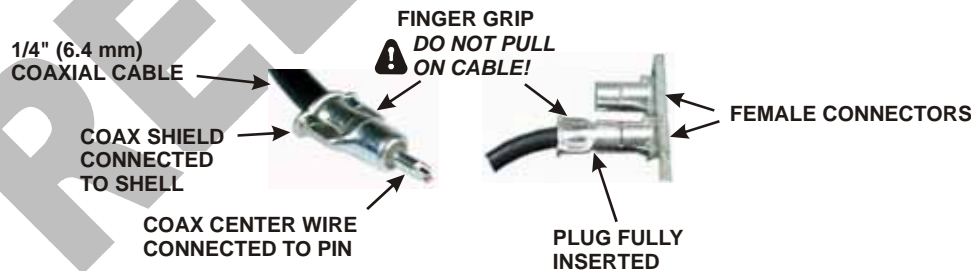

Figure 53. TMP Cable Connectors.

□ Install the three TMP cables between connectors on the KREF3 board, the main RF board and the KSYN3 board as follows. Handle the connectors by the finger-grip area shown in Figure 53, especially if you unplug a connector. **Do not pull on the coaxial cable to unplug a connector!** When mating the connectors, be sure the plugs are fully inserted as shown in Figure 53. To make the connectors easier to mate, first be sure the center pin is started in the socket, then you may twist the connector back and forth while holding it by the metal ears if needed to seat it fully as shown in Figure 53.

- KREF3 board J7 to RF board J65.
- KREF3 board J6 to RF board J81.
- KREF3 board J2 to KSYN3 board J83.

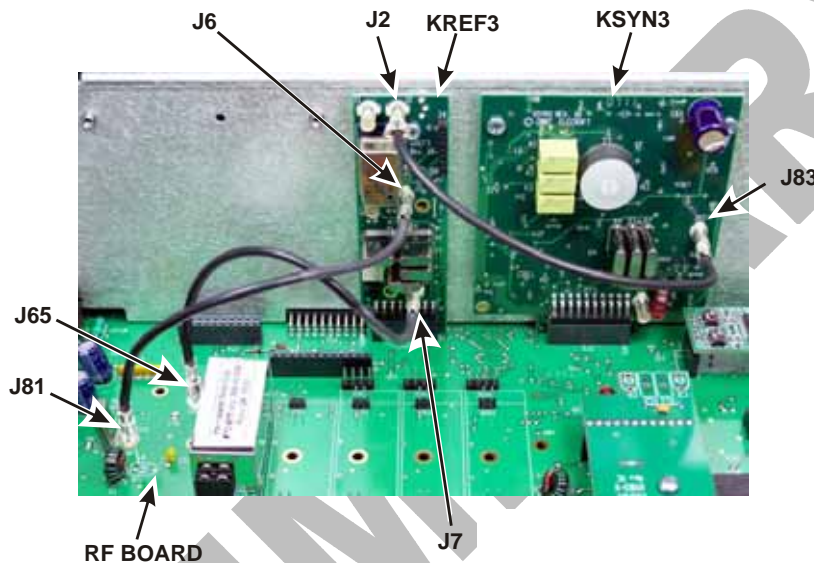

Figure 54. Installing KREF3 TMP Cables.

KPA3 Installation

□ If you have purchased the KPA3 optional 100-watt amplifier module with your kit, go to the *Installation Procedure* in the KPA3 manual that and install the option now, following the instructions in the *Special Note to K3 Kit Builders*. If you do not have the KPA3 module, install the larger blank panel in the opening on rear panel using a 3/16" (4.8 mm) black pan-head screw into the threaded bushing at each corner. Do not use washers under the screws.

Bottom Cover

The bottom cover is divided into rear and forward sections. The rear section is thicker than the forward section to act more efficiently as a heat sink for the there LPA transistors.

Bottom Cover Installation

- Install four 1/4" (6.4 mm) standoffs on the bottom of the RF board as shown in Figure 55. Be sure you mount the standoffs on the bottom of the board as shown.

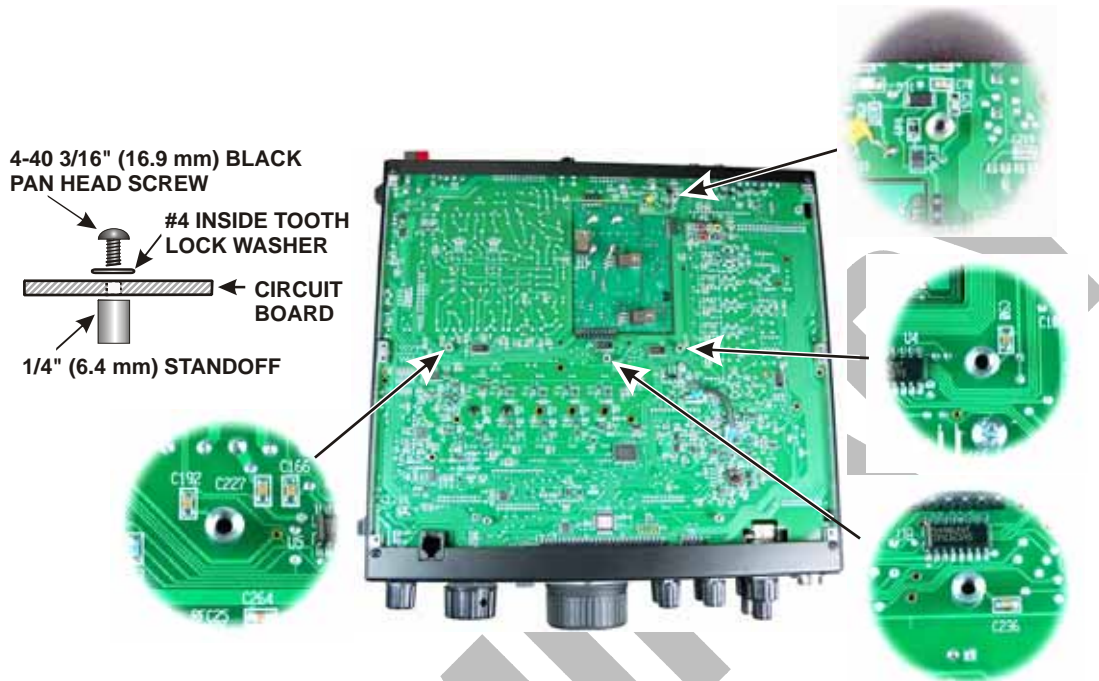

Figure 55. Installing Standoffs on RF Board.

- Locate bottom cover section B. This cover measures about 4-3/8" (11 cm) by 10-9/16 (27 cm) and has eight rectangular slots cut in it. (Do not confuse this cover with section A which is the same size but has no rectangular holes.) Note that, on one side, bare metal is exposed in some areas. This side will face inside the K3. The bare metal ensures good electrical contact with the other cabinet parts and good thermal contact with the heat sinks for Q2, Q4 and Q5 on the LPA circuit board.

- Two of the screw holes inside bottom cover section B have *not* had the paint removed from them. These are the mounting holes for the two rear feet. Attach each foot as shown in Figure 56.

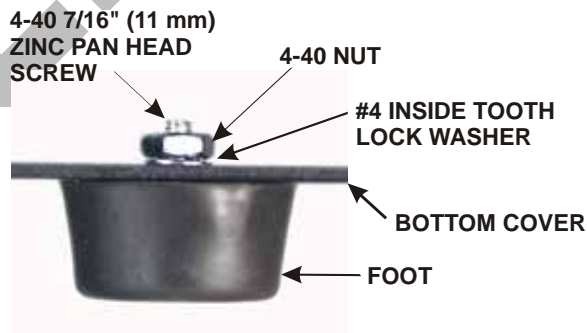

Figure 56. Installing Rear Feet.

- Locate bottom cover section A. This is cover is the same size as the section B cover. about 4-3/8" (11 cm) by 10-9/16 (27 cm). Like the section B cover, one side is fully painted. That is the outside. The other side has areas of bare metal left to ensure good electrical contact with the other cabinet parts.

- Turn the K3 over so the bottom is exposed. Position the bottom cover section over the rear part so the feet are nearest the back edge and the nine screw holes line up with 2D fasteners at the corners, the standoffs along

the front edge and the three power transistors on the LPA module. The bottom cover rests directly against the power transistors. No thermal pads, heat compound or other material should be used.

Attach the bottom cover rear section as follows:

1. Test fit the panel and note that three holes near the center of the bottom cover will line up with the transistors on the LPA board. The remaining holes will line up with 2D fasteners and standoffs.
2. Place the panel in position and start three 4-40 1/4" black pan head screws into the transistors through the holes near the center. Do not use washers. Do not tighten the screws yet.
3. Start seven 4-40 3/16" black pan head screws into the remaining holes. Do not use washers.
4. Tighten all ten screws.

Attach one tilt stand foot to the bottom cover as shown in Figure 57 using a 4-40 7/16" (11 mm) zinc pan head screw. The foot goes on the fully-painted side of the cover, oriented as shown. Be sure the cut-away side of the foot is farthest from the edge of the panel and the hole for the tilt stand faces the holes for the other foot. Use a #4 inside tooth lock washer and #4 nut to secure each screw. Do not tighten the hardware. Start the nuts onto the screws only a few turns so the foot is free to move about.



Figure 57. Installing Tilt Stand.

Attach the second tilt stand foot, making sure the ends of the tilt stand are resting in the holes provided in the feet, then tighten all four screws to secure the feet to the panel.

Position the forward bottom cover on the K3 with the feet nearest the front panel. Attach the cover with seven 4-40 3/16" black round head screws. Do not use washers.

Battery BT1

Battery BT1 Function

BT1 is a 3-volt lithium coin cell that provides the operating voltage for the real-time-clock IC (RTC) on the front panel when the K3 is turned off. Depending on the type of cell, BT1 could last from 2 to 10 years, thanks to the extremely low current drain of the RTC – on the order of a few microamps. The RTC keeps track of the full date and 24-hour time, either of which can be displayed on the VFO B portion of the LCD.

Battery BT1 Installation Procedure

- Insert the CR2032 cell into battery holder BT1 as shown in Figure 58.

SLIDE CR2032 CELL
INTO BT1 BATTERY HOLDER



⚠ OBSERVE POLARITY!
ALIGN + SIDE OF CELL WITH + ON PC BOARD.

Figure 58. Installing BT1.

Top Cover and Speaker

If you have the KPA3 100-watt module to install, recommend you install the top cover and speaker at this time for initial testing and calibration of the basic 10-watt K3 configuration.

- If you have installed the KPA3 100-watt amplifier module in your K3, the chassis stiffening bracket is already in place. In that case skip this step. Otherwise mount the chassis stiffening bracket on the underside of the cover as shown in Figure 59. Do not use washers.

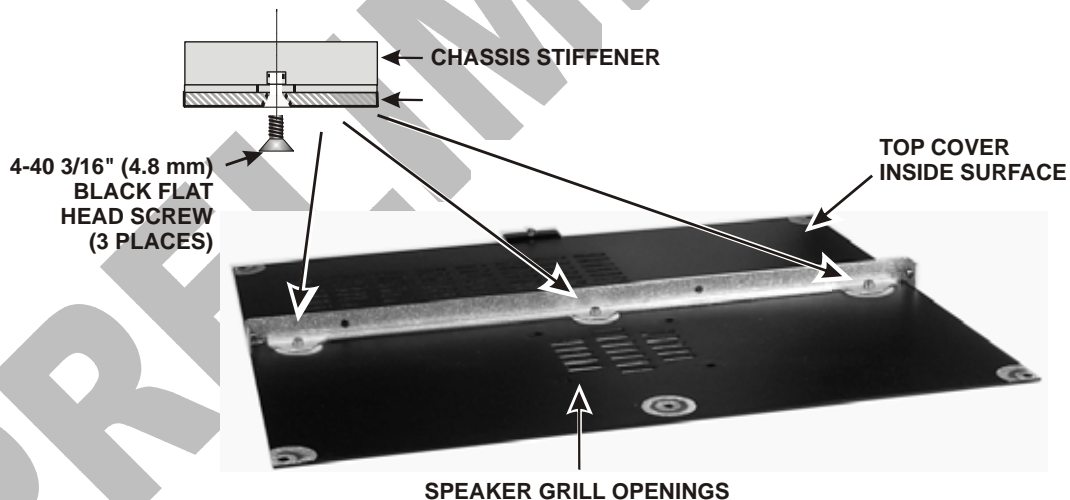

Figure 59. Attaching Chassis Stiffener to Top Cover.

- Trim the grill cloth to cover the speaker grill openings and overlap the four holes for the loudspeaker mounting screws. Mark and cut four holes in the grill cloth for screws to pass through the cloth. The grill cloth is shown as it needs to fit after the speaker is mounted in Figure 60. If you install the KPA3 100-watt amplifier, the stiffener will be attached to the chassis and cannot be removed with the cover. In that case, the grill cloth must be trimmed so it cannot become trapped between chassis stiffener and the top cover.

⚠ CAUTION!

Failing to install the fiber washers as shown in the next step or over-tightening the screws so that the speaker mounting flanges are distorted may damage the speaker, causing distorted, fuzzy sound.

- Mount the speaker using the hardware shown in Figure 60. Be sure to include the fiber washers between the speaker flanges and the grill cloth as shown. They are necessary to avoid distorting the speaker frame. Also, take care not to over-tighten the screws so that the speaker mounting flanges are bent.

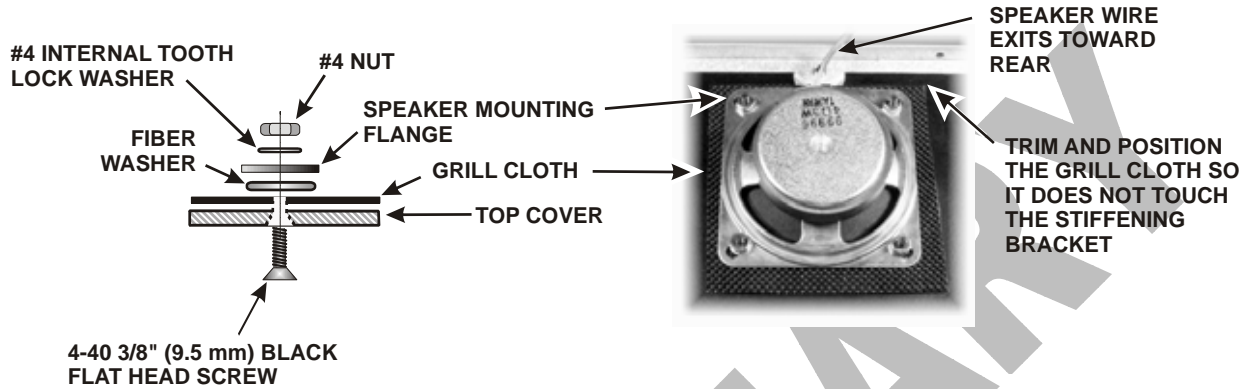

Figure 60. Mounting Loudspeaker.

- Install the magnetic shield over the speaker magnet as shown in Figure 61.

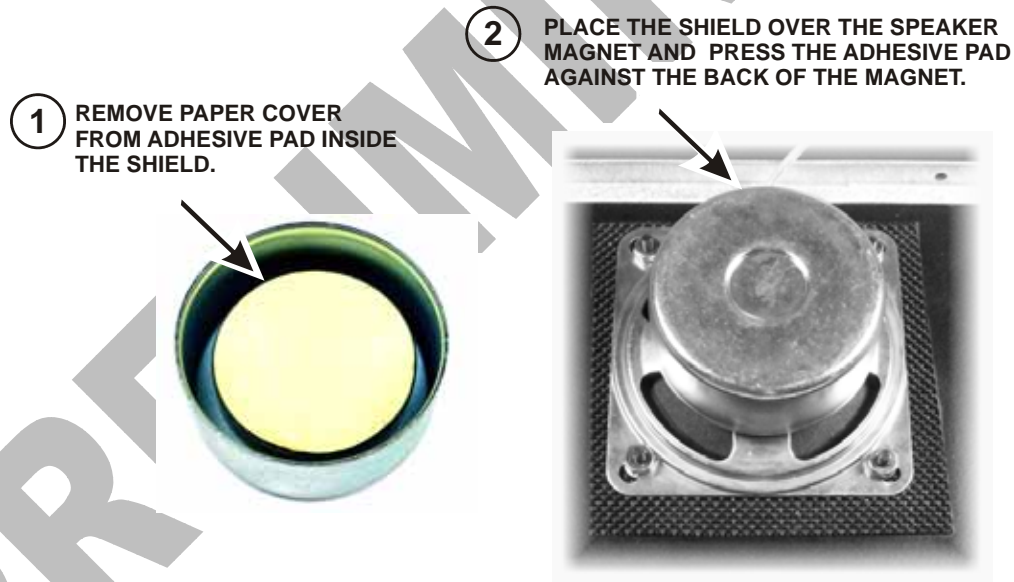

Figure 61. Installing Speaker Magnet Shield.

- Connect the speaker cable to P25 of the KIO3 board as shown in Figure 62.

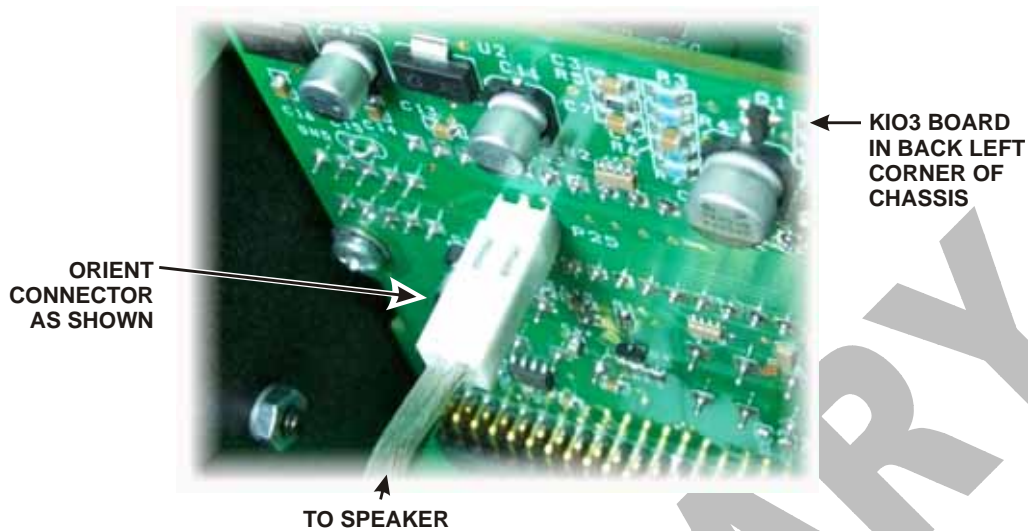

Figure 62. Connecting Speaker to KIO3 Board.

- Place the top cover on the K3 with the tab at the rear extending under the lip of the rear panel. Secure the top cover with seven 4-40 3/16" (4.8 mm) black flat head screws: five on the top and through each side panel into the stiffing bracket. Do not use washers.

Test and Calibration

It's time to apply power! In the following tests and procedures you will check out and calibrate essential functions of your basic K3. Have your Owner's Manual handy. Most of these procedures are in your K3 Owner's Manual where you can find them easily in the future if you need them.

⚠ Using Tap/Hold Switches: Most K3 switches have two functions. **Tapping** activates the function labeled on the switch. **Holding** (~1/2 sec.) activates the function labeled beneath the switch.

Initial Power Checks

- Connect your 11-16 VDC power supply to the red and black 12VDC IN connector on the back of your K3. Don't connect anything else to your rig until instructed to do so.
- On the front panel, tap **POWER** to turn the K3 on. The LCD display should illuminate as it did before. It will probably show an Error message, e.g. ERR PLL or ERR PL1. This is normal! It is reporting that the synthesizer has not been calibrated. Tap **DISPLAY** to clear the error message. Other error messages may follow, depending upon which modules you have installed, indicating that they have not been initialized yet. Press display until you have cleared the error messages.
- When you have cleared the error messages, turn to your Owner's manual, *Getting Started, Initial Power-Up* and display the current drain of your K3. It should be between 850 mA and 1.0 Amperes with no subassemblies other than the KNB3, KIO3, DSP, and KANT3 or KAT3 installed.
- Turn the VFO B knob to display the supply voltage. It should agree with the voltage your power supply is delivering to the K3 (the K3 compensates for the voltage drop produced by the reverse polarity protection diode).

Synthesizer Calibration

- Hold GROUP to access the CONFIG menu, then rotate VFO to display TECH MD. With the VFO B control set the TECH MD parameter to ON.
- Refer to the *Calibration Procedures* in your Owner's Manual and perform the *Synthesizer* calibration.
- When the calibration process is completed, press the BAND switch to cycle through all the bands from 160 meters through 6 meters and verify that there are no CAL PLL error messages on the display. That indicates that the synthesizer is calibrated on all the bands.

Filter Setup

- Turn to the *Crystal Filter Installation and Setup* section of your Owner's Manual and perform the following procedures:
 - *Filter Bandwidth Setup*
 - *Filter Center Frequency Setup*
 - *Receive Filter Enables*
 - *Filter Loss Compensation*
 - *Transmit Filter Selection*

Option Modules

- Enable the option modules, such as the KNB3 and, if installed, the KAT3 and KXV3, as described in the *Option Module Enables* section of your Owner's Manual.

Transmitter Test

- Connect a dummy load capable of dissipating 5 watts to the ANT1 output.
- If your K3 is equipped with a KAT3, be sure it is in bypass (press GROUP, turn VFO B to KAT3 and then turn VFO A as needed to display BYP, then exit the menu).
- Set the PWR control for 5.0 watts indicated on the display.
- Tap TUNE. The TX LED should light and the display should show the SWR of your dummy load at the top and the power (5.0 W) below it.
- Tap TUNE (or any button) to exit the mode.
- Repeat the above test on all bands from 160 through 6 meters and verify there are not error messages displayed.

Wattmeter Calibration (Optional)

The wattmeter is reasonably accurate as it is supplied. However, if you have an accurate external watt meter you can adjust the K3 to match its readings at low power (5 watts) high power (50 watts) and, if you have the KXV3 module installed, at 0.5 milliwatts output at the KXV3 transverter interface. Refer to *Calibration Procedures, Wattmeter* in your Owner's Manual.

Reference Oscillator Frequency (Optional)

Both the standard 5 ppm and optional 1 ppm reference oscillators can be calibrated for improved accuracy if you have a highly-accurate frequency counter or by zero-beating a known, accurate on-air signal such as a commercial broadcast station. Refer to *Calibration Procedures, Reference Oscillator* in your Owner's manual.

KPA3 100-Watt Module Installation

If you have the 100-watt module, turn to the KPA3 Option manual and follow the instructions to install it now. Be sure you have completed the above Test and Calibration procedures before installing the KPA3 module.

PRELIMINARY

Appendix A Illustrated Parts List









ILLUSTRATION	DESCRIPTION	QTY.	ELECRAFT PART NO.
	Front Panel Printed Circuit Board Assembly ⚠ ESD Sensitive. Follow ESD safe handling procedures. Keep in ESD-safe bag until installed.	1	E850242
	K3 DSP Printed Circuit Board Assembly ⚠ ESD Sensitive. Follow ESD safe handling procedures. Keep in ESD-safe bag until installed.	1	E850233
	RF Board ⚠ ESD Sensitive. Follow ESD safe handling procedures. Keep in ESD-safe bag until installed.	1	E850261
	Low Power Amplifier (LPA) Board ⚠ ESD Sensitive. Follow ESD safe handling procedures. Keep in ESD-safe bag until installed.	1	E850256
	KR MXR Mixer Board ⚠ ESD Sensitive. Follow ESD safe handling procedures. Keep in ESD-safe bag until installed.	1	E850257
	KNB3 Noise Blanker Board ⚠ ESD Sensitive. Follow ESD safe handling procedures. Keep in ESD-safe bag until installed.	1	E850280
	KANT3 Board Note: This board is not supplied if you purchased the KAT3 automatic antenna tuner option with your K3 kit.	1	
	KREF3 Board ⚠ ESD Sensitive. Follow ESD safe handling procedures. Keep in ESD-safe bag until installed.	1	E850254





ILLUSTRATION	DESCRIPTION	QTY.	ELECRAFT PART NO.
	KSYN3 Board ⚠ ESD Sensitive. Follow ESD safe handling procedures. Keep in ESD-safe bag until installed.	1	E850260
	KIO3 Main Board ⚠ ESD Sensitive. Follow ESD safe handling procedures. Keep in ESD-safe bag until installed.	1	E850237
	KIO3 Audio I/O Module ⚠ ESD Sensitive. Follow ESD safe handling procedures. Keep in ESD-safe bag until installed.	1	E850236
	KIO3 Remote I/O Module ⚠ ESD Sensitive. Follow ESD safe handling procedures. Keep in ESD-safe bag until installed.	1	E850235
	Encoder Assembly	2	E850239
	KFL3A-2.8K Filter	1	E850249
	KREF3 Oscillator Module, 49.380 MHz, either 1 ppm or 5 ppm stability	1	5 ppm: 1 ppm:
	TMP Cables	3	E100282
	SO239 (UHF) Female Panel Mount Connector with cable	1	E620064
	Front Panel	1	E100209SS
	Left Side Panel	1	E100210

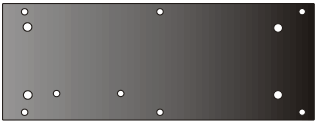
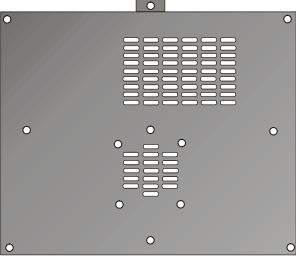

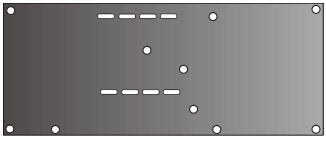

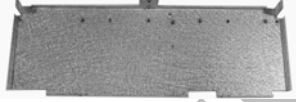





ILLUSTRATION	DESCRIPTION	QTY.	ELECRAFT PART NO.
	Right Side Panel	1	E100211
	Top Cover	1	E100212
	Bottom Cover A	1	E100213
	Bottom Cover B	1	E100221
	Rear Panel	1	E100214SS
	Front Panel Shield	1	E100216
	Top Cover Stiffener	1	E100222
	Panel, Blank (KXV3 I/O) Note: This part is not supplied if you purchased the KXV3 I/O option with your K3 kit.	1	E100223
	KIO3 Panel	1	E100218SS
	Panel, Blank (KPA3 Fans) Note: This part is not supplied if you purchased the KPA 100 watt amplifier option with your K3 kit.	1	E850297
	Bezel (LCD cover), K3	1	E100195

ILLUSTRATION	DESCRIPTION	QTY.	ELECRAFT PART NO.
	Trim Panel, K3 VFO	1	E100197
	Serial Number Label	1	E980137
	Knob, VFO A Tuning	1	E980093
	Finger Grip, Main VFO Tuning Knob	1	E980094
	Knob, VFO B Tuning	1	E980090
	Knob, Concentric Shaft, Large	2	E980092
	Knob, Concentric Shaft, Small	2	E980091
	Knob, Small Encoder Shaft	4	E980088
	Knob, RIT/XIT	1	E980089
	Felt Washer	3	E700033
	Knurled Nut	1	E700138
	Carrying Handle (including strap, spring insert and two end caps)	1	E980115
	Power Cable Assembly	1	E850301



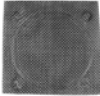

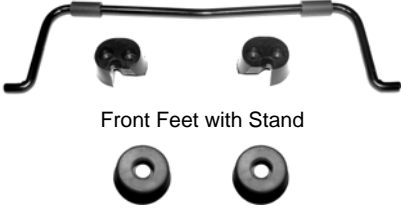





ILLUSTRATION	DESCRIPTION	QTY.	ELECRAFT PART NO.
	Loudspeaker with attached wire and connector	1	E850300
	Loudspeaker Shield	1	E980087
	Loudspeaker Grill Cloth	1	E980053
	#4 Fiber Washer	4	E700031
 <p data-bbox="305 877 508 898">Front Feet with Stand</p> <p data-bbox="358 989 454 1010">Rear Feet</p>	Bottom Feet with tilt stand	1	E980098
	SO239 Hole Cover	1	E980135
	BNC Hole Cover	1	E980136
	Thumbscrew, #6	1	E700070
	Pad, Self Adhesive	2	E700127
	2D Fastener	10	E100078
 <p data-bbox="326 1619 488 1640">Typical Standoffs</p>	Standoff, 2/56, 5/16" (7.9 mm) long	2	E700122
	Standoff, 4-40, 1/4" (6.4 mm) long	6	E700026
	Standoff, 4-40, 5/16" (7.9 mm) long	2	E700121
	Standoff, 4-40, 7/16" (11 mm) long	2	E700017
	Standoff, 4-40, 1/2" (13 mm) long	3	E700061
	Standoff, 4-40, 5/8" (15.9 mm) long	3	E700003
	Standoff, 4-40, 1-1/4" (31.8 mm) long	2	E700119
	Standoff, 4-40, 1-15/16" (49.2 mm) long	2	E700135









ILLUSTRATION	DESCRIPTION	QTY.	ELECRAFT PART NO.
<p>Typical Nuts</p> 	Nut, 4-40	24	E700011
	Nut, 6-32	3	E700069
	Nut, 3/8" (9.5 mm) Hex	6	E700125
<p>Typical Flat Head Screw</p> 	Screw, 4-40, 3/16" (4.8 mm) Black, Flat Head	24	E700025
	Screw, 4-40, 3/8" (9.5 mm) Black, Flat Head	6	E700131
	Screw, 4-40, 1/2" (13 mm) Black, Flat Head	1	E700132
<p>Typical Pan Head Screws</p>  <p>Zinc Black</p>	Screw, 2-56, 1/8" (3.2 mm) Black, Pan head	4	E700084
	Screw, 2-56, 1/4" (6.4 mm) Black, Pan Head	4	E700124
	Screw, 4-40, 3/16" (4.8 mm), Black, Pan Head	10	E700015
	Screw, 4-40, 1/4" (6.4 mm) Zinc, Pan Head	8	E700005
	Screw, 4-40, 1/4" (6.4 mm) Black, Pan Head	2	E700009
	Screw, 4-40, 7/16" (11 mm) Zinc, Pan Head	6	E70032
	Screw, 6-32, 1/2" (13 mm), Black, Pan Head	2	
	Lockwasher, #2, Split	2	E700123
	Lockwasher #4, Split	35	E700004
	Lockwasher, #6, Split	2	E700041
	Lockwasher, #4, Inside Tooth	29	E700010
	Washer, 5/16" (7.9 mm) Flat	1	E700137
	Washer, Flat, #6	2	E70067

ILLUSTRATION	DESCRIPTION	QTY.	ELECRAFT PART NO.
	Flat Washer	1	E700137
	Jackscrew Nut, 4-40	4	E700052
	Grommet Bumper, 7/16" Round (Side panel feet)	4	E980141

PRELIMINARY

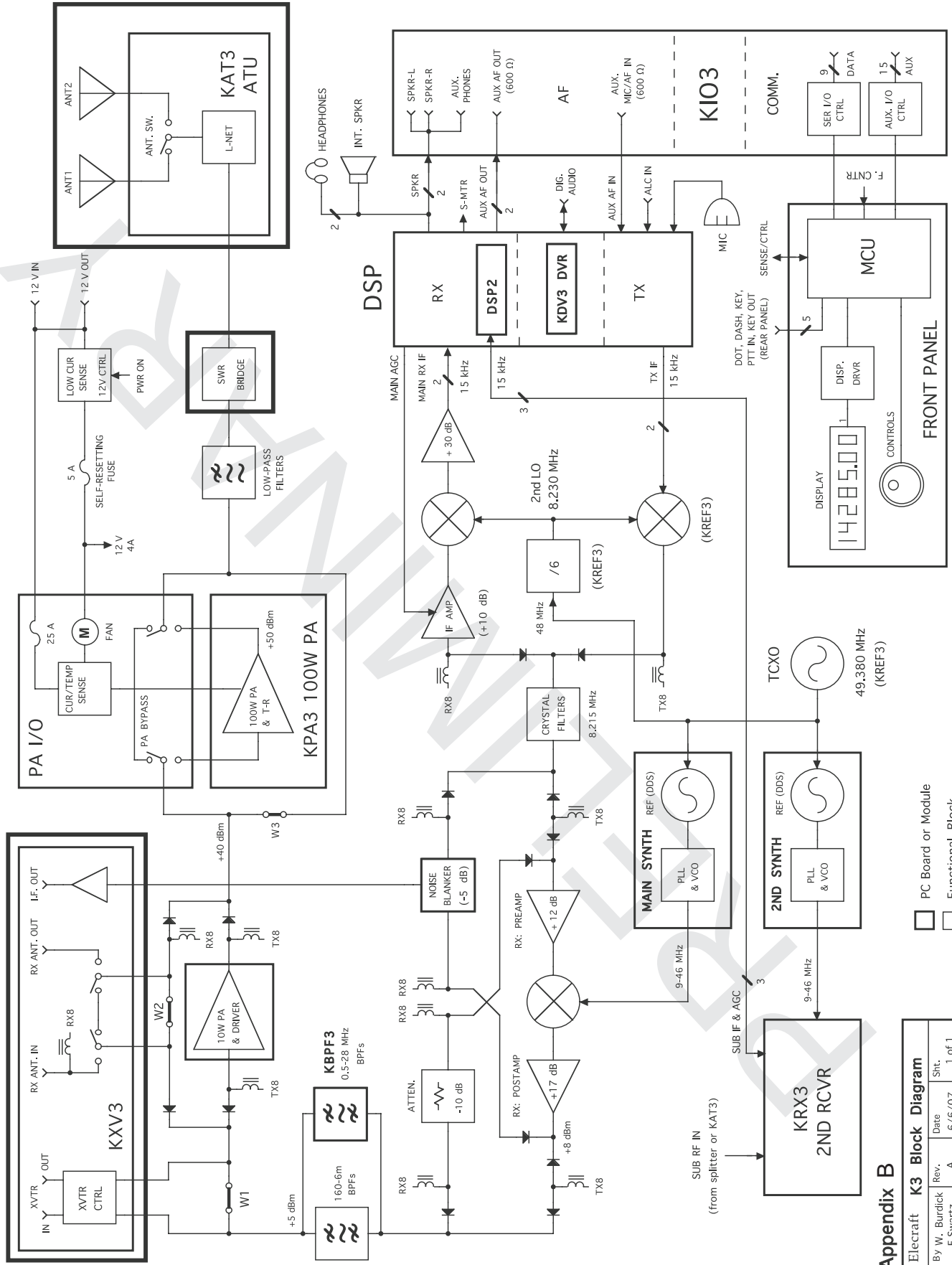

Appendix B
 Elecraft **K3** Block Diagram
 By W. Burdick Rev. A Date 6/6/07 Sht. 1 of 1
 E.Swartz